



English

Workbook

2



Blank lined area for writing, containing the handwritten signature: *Ткачук Е. В.*

+ Підсумкові
семестрові
роботи



До підручника
О. Карпюк



Оксана Косован
Надія Вітушинська

АНГЛІЙСЬКА МОВА

Робочий зошит для 2 класу
закладів загальної середньої освіти

(до підручника О. Карпюк)



TM

Тернопіль
Видавництво «Підручники і посібники»
2020

УДК 372.881.111.1
К71

Літературне редагування україномовного тексту *Любов Левчук*
Дизайн обкладинки *Юлія Литвин*
Художник *Віктор Стецюк*

УМОВНІ ПОЗНАЧЕННЯ

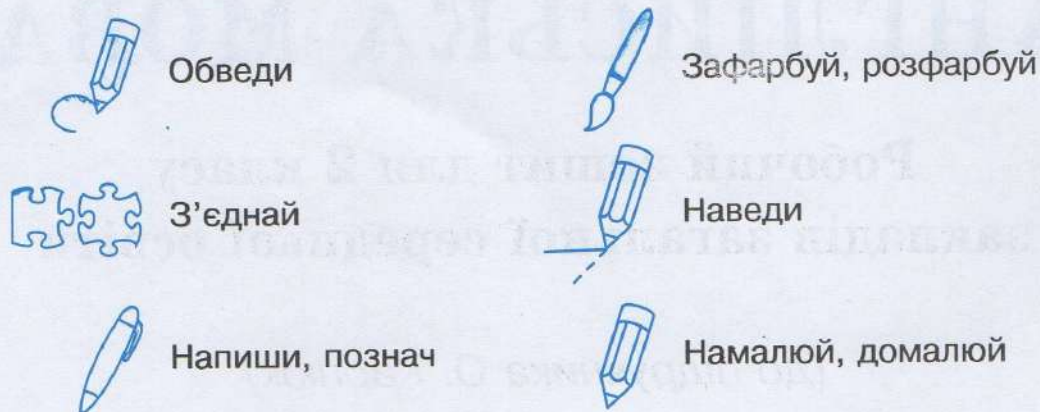

Косован О.

К71 Англійська мова : робочий зошит для 2 кл. закл. загал. серед. освіти (до підручника О. Карпюк) / О. Косован, Н. Вітушинська. — Тернопіль : Підручники і посібники, 2020. — 80 с.

ISBN 978-966-07-3496-8

Зошит укладено відповідно до Типових освітніх програм НУШ і підручника для 2 класу (Карпюк О. Д. Англійська мова : підручник для 2 кл. закл. загал. серед. освіти (з аудіосупроводом). Різноманітність завдань, уміщених у зошиті, сприятиме збагаченню словникового запасу другокласників, закріпленню та систематизації набутих знань, розвитку уяви, уваги, мислення.

Для учнів 2 класу та вчителів англійської мови.

УДК 372.811.111.1

ISBN 978-966-07-3496-8

© Косован О., Вітушинська Н., 2019

1



Name and circle the first letters.

Назви й обведи перші літери.



a **b** c



g f c



b e i



y e c



j p f



m q y



b f k

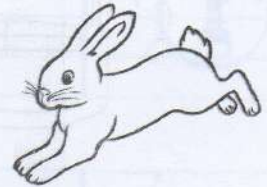

r n a

2



Name and write the first letters.

Назви та напиши перші літери.

Ff

Hh

Gg

Ww

Zz

Oo



Oo



Gg



Hh



Ww



Ff



Zz

1



Circle the correct number and say.
Обведи відповідну кількість і скажи.

Two books.

2

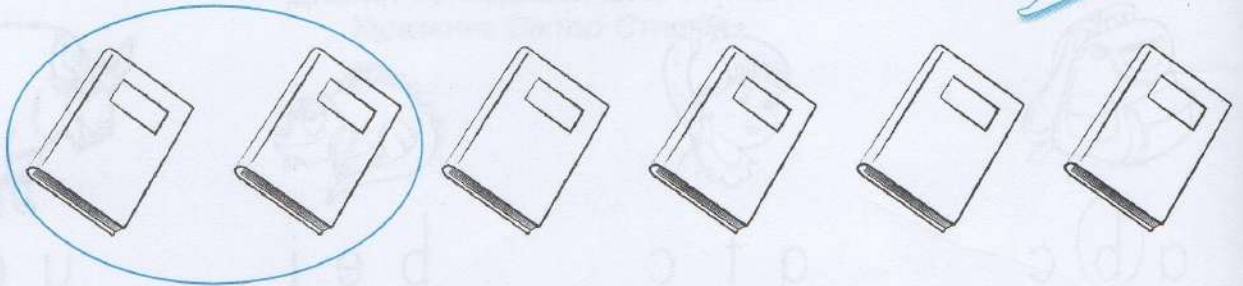

1



4



3

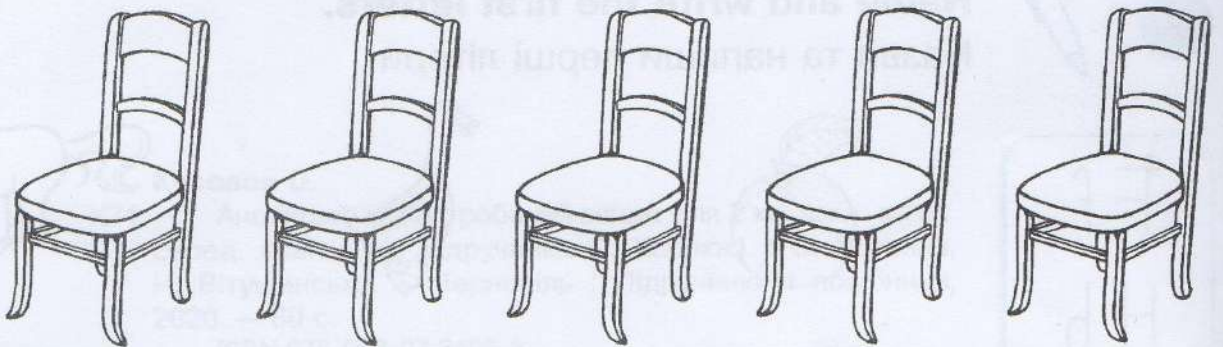

6

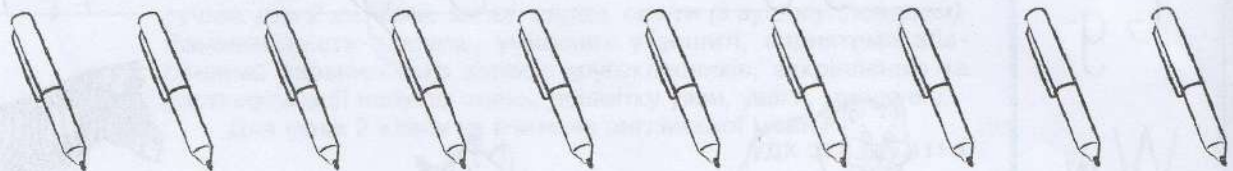

5

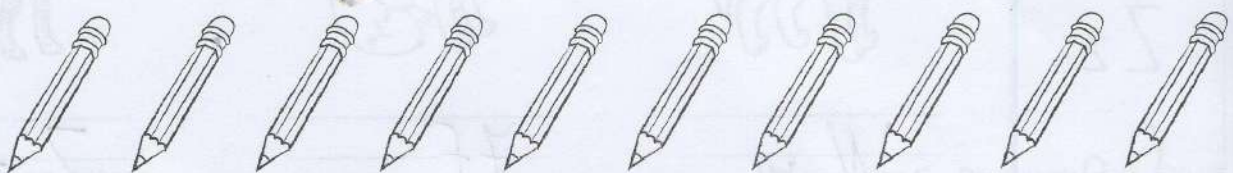

1



Write the letters from A to Z. Дopiши лiтери вiд A до Z.

A a B b C c D d E e F f

G g H h I i J j K k L l

M m N n O o P p Q q R r S s

T t U u V v W w X x Y y Z z

2



Colour blue, yellow, red, green. Say. Розфарбуй у блакитний, жовтий, червоний, зелений кольори. Скажи.

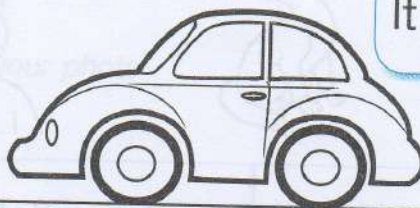
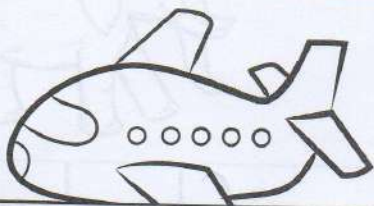

It is a blue plane.

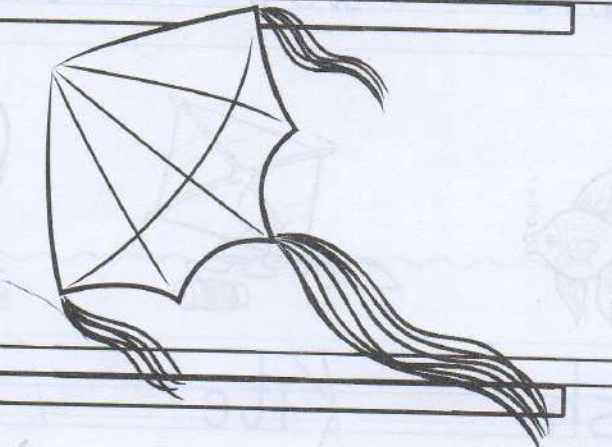

1  Name and match. Назви та з'єднай.

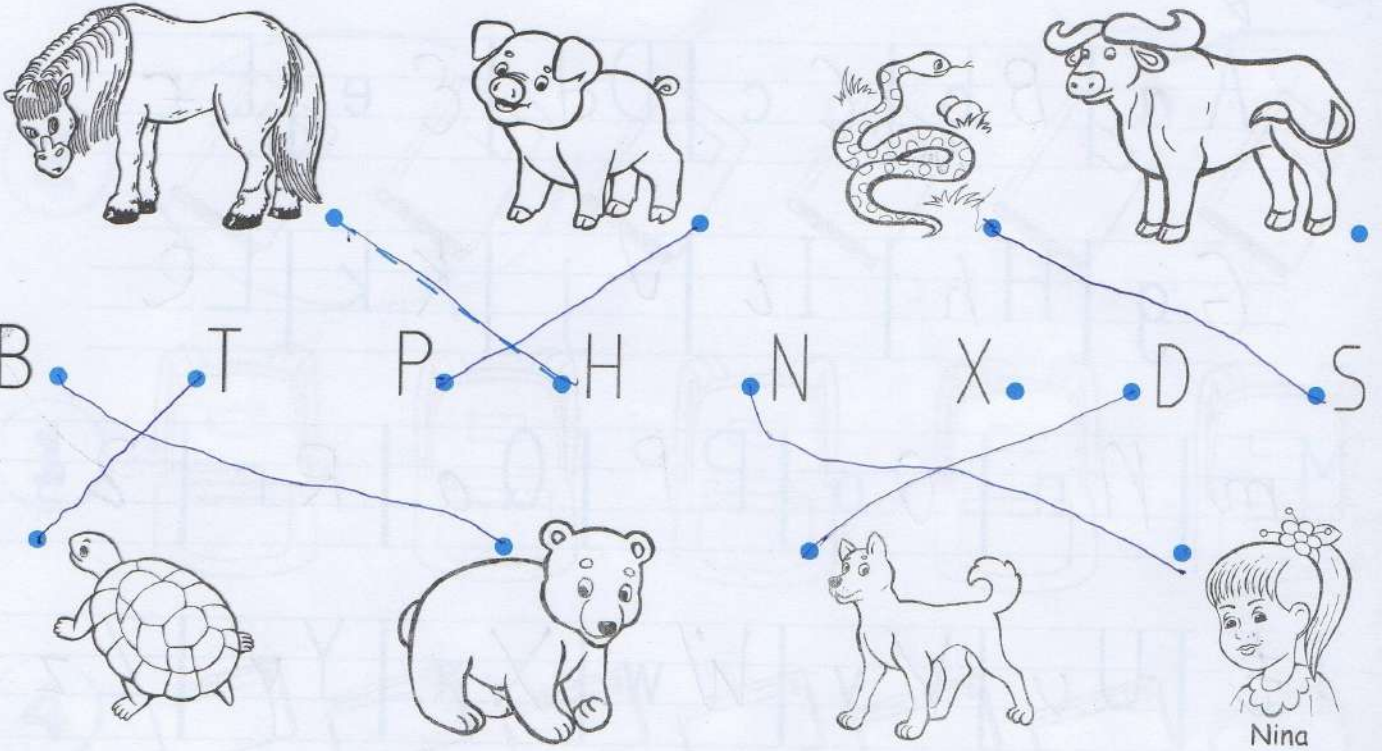

B. T P. H N X. D S

Nina

2  Name and write the first letters. Назви та допиши перші літери.



ant cat uncle elephant

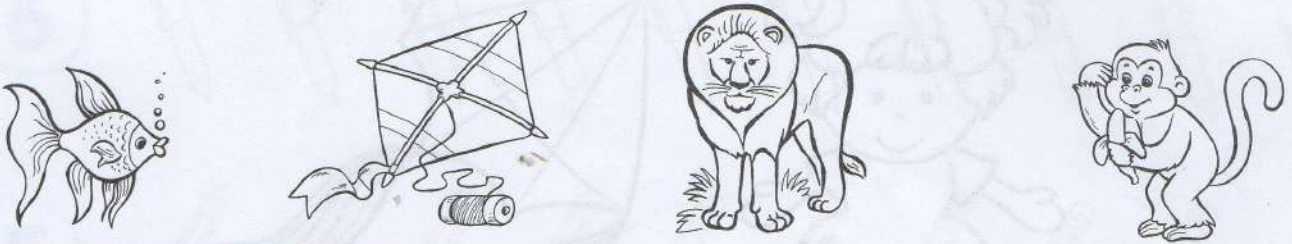

fish kite lion monkey

1



Сору. Перепиши.

What's your name?

My name is Bill.

2



Stick your photo and complete.

Наклей свое фото та допиши.

Stick your photo

My name is _____

1



Draw your family and tell about it.

Намалюй свою сім'ю і розкажи про неї.

Here's my family: ...

2



Complete and copy. Закінчи речення і перепиши.

My name is My surname is

1



Copy. Перепиши.

— I like TV. What about you?

— I like books.

2



Tick (✓) about yourself and say.

Познач (✓), що стосується тебе та скажи.

I'm

I like

1



4

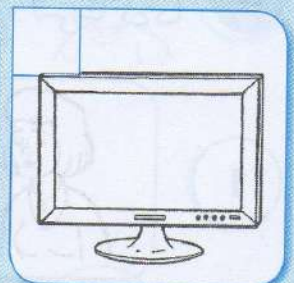
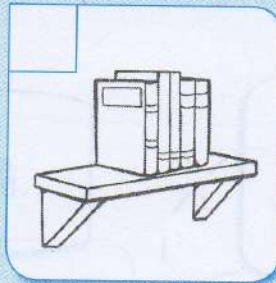



2





3



1  Look and write. Поглянь і напиши.

1  **r + un =** _____

2  **h + op =** _____

3  **s + it =** _____

2  Name, match and write. Назви, з'єднай і напиши.

1  **s** **en** _____

2  **m** **ad** _____

3  **p** **oll** _____

4  **d** **um** _____

1  Join and say. З'єднай і скажи.

What's your name? My name is Ben.

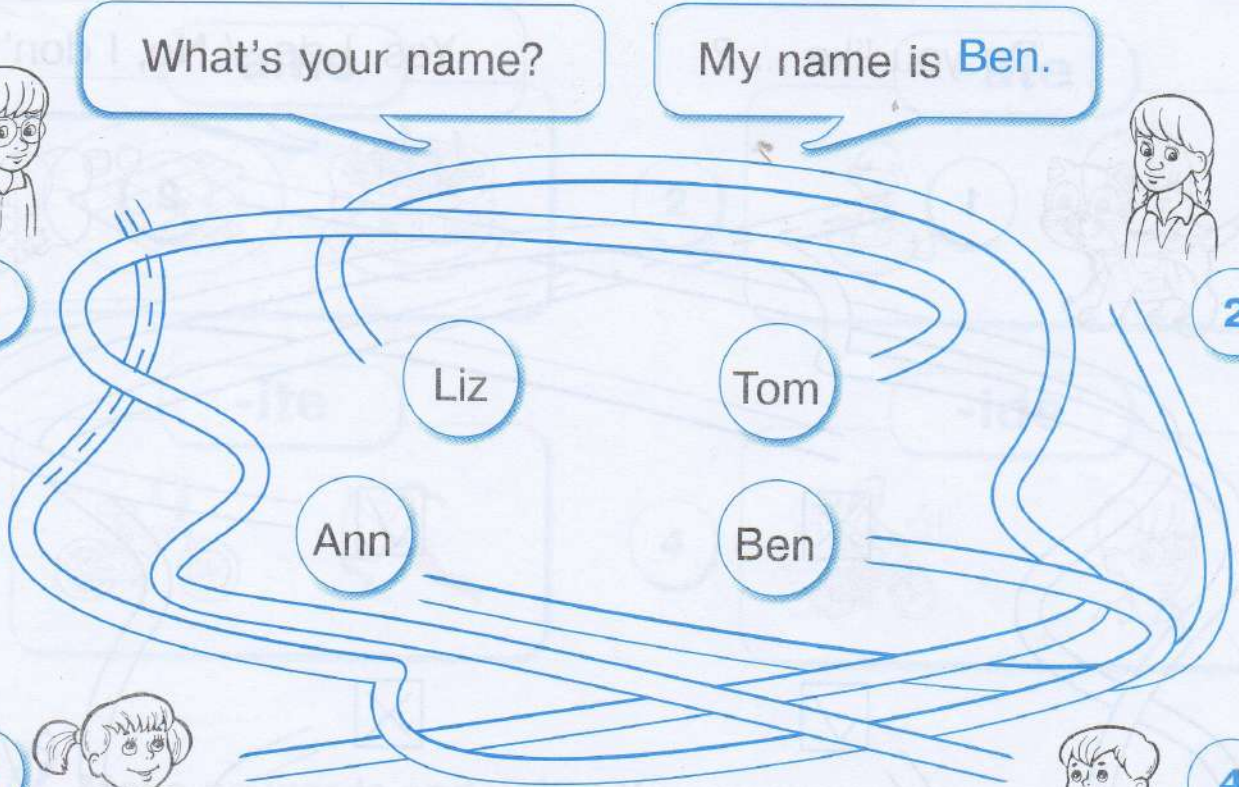

1 2 3 4

Liz Tom Ann Ben

2  Write answers. Напиши відповіді.

How old are you?

10 I am ten.

6

5

9

1 Join and say. З'єднай і скажи.

Do you like ... ?

Yes, I do. / No, I don't.

1

2

3

4

✓

✗

✗

✓

2 Match and say. З'єднай і скажи.



He is at work.





school

work

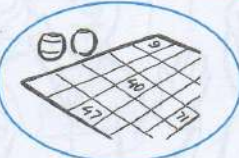

home

1  Circle the correct picture. Обведи відповідний малюнок.



-ame

1  



-ate

2  

-ite

3  

-ide

4  

2  Make up words and write. Утвори слова та напиши.

-ike

1  MI
MIKE

-ile

2  _____

-ane

3  _____

1

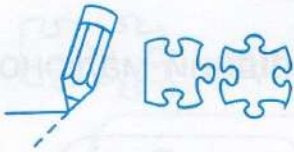

Trace and match. Наведи та з'єднай.

my cousin
my aunt
my uncle



2



Match and say. З'єднай і скажи.

She is a doctor.

1



2

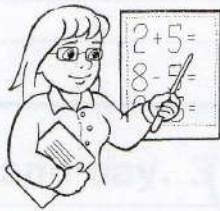

3



4

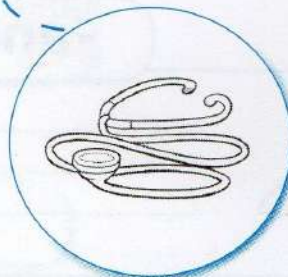
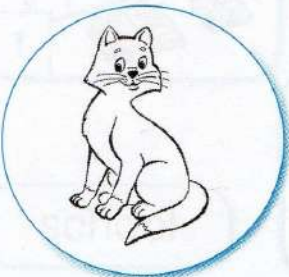

1



Join and write. З'єднай і напиши.

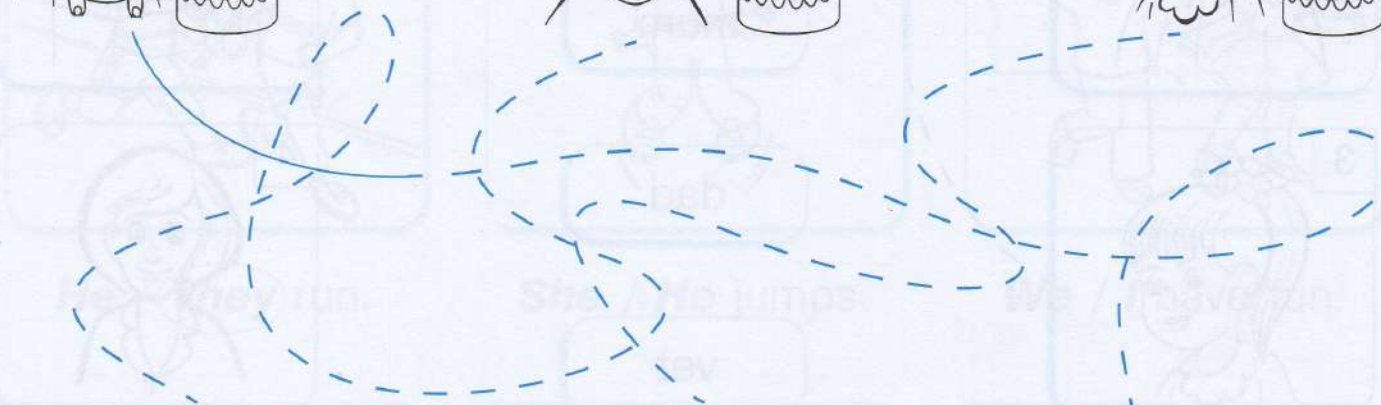

He is _____

2



Draw yourself and write how old are you.

Намалюй себе та напиши, скільки тобі років.

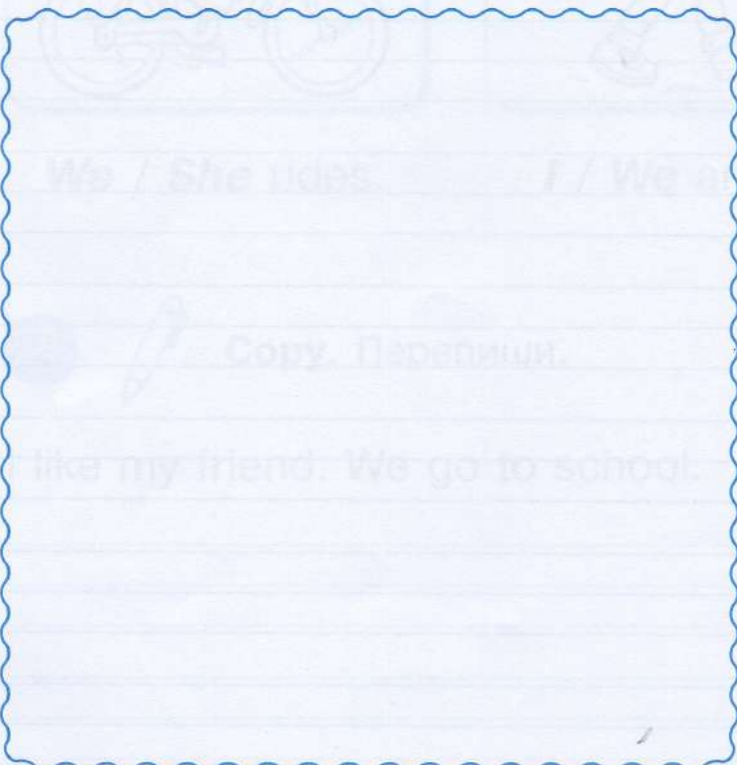

I am _____

3



Read and match. Прочитай і з'єднай.



Kate

mum

dad

vet



4



Stick your family photo and complete.

Наклей своє сімейне фото та напиши, хто є в твоїй сім'ї.

Stick your family photo

Here's my family:

1



Read and circle. Прочитай та обведи.



He / **They** run.

She / **He** jumps.

We / I have fun.



We / She rides.

I / **We** am six.

We / She sings.

2



Copy. Перепиши.

I like my friend. We go to school.



1 Read and write. Прочитай і напиши.



Ted and Liz

They



Kate

Blank writing box with two lines.



Tom

Blank writing box with two lines.



Ben and I

Blank writing box with two lines.



Sam and I

Blank writing box with two lines.



dad

Blank writing box with two lines.



2 Draw your friend and copy.

Намалюй свого друга/подругу та перепиши.

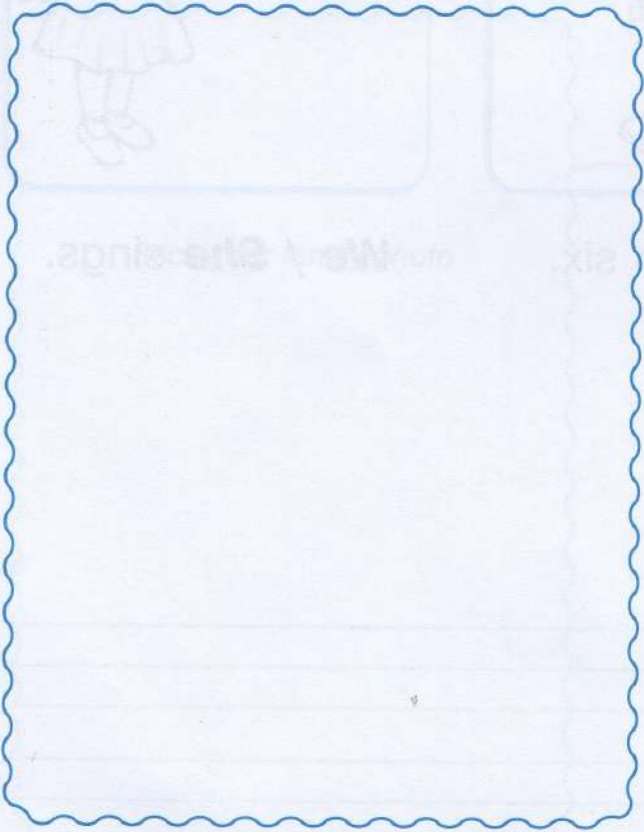

We are friends.

We like to play together.

Handwriting practice lines for copying the text.



1 Name, match and write. Назви, з'єднай і напиши.

1				_____
2				_____
3				_____
4				_____

2 **Сору.** Перепиши.

Kate and Pete like games.
Sue runs and jumps.
It is fun!

1  Write the words in ABC order.
 Напиши слова за абеткою.

Nice, funny, pretty, clever, friend, toy, pet.

2  Join and write answers. З'єднай і напиши відповіді.

Yes, it is.

No, it isn't.

1 Is it a girl?



2 Is it a boy?



3 Is it a girl?



4 Is it a boy?



1  **Make up sentences and write.** Утвори речення та напиши.

1 cat / funny. / My / is

My cat is funny.

2 a / friend / best / is / dog. / My

3 pretty / clever. / is / and / Mary

4 pretty. / is / My / nice / doll / and

2  **Write about your best friend. Use the example.** Напиши про свого найкращого друга/подругу за зразком.

My best friend is my robot Button.
He is clever. He is funny, too.
He can walk.



1  **Make up words and write.** Утвори та напиши слова.

-ome

1



-ose

2



-o

3



2



Match the rhyming words.

З'єднай слова, які римуються.

lock

Nick

back

duck

pack

luck

cock

tick



1 Join and write. З'єднай і напиши.

1 Ann

2 Sam

3 Kim

4 Ron

1 Ann likes cheese and bananas.

2 _____

3 _____

4 _____

1 Write the names in ABC order.
Напиши імена за абеткою.

Fred, Kate, Sue, Mick, Jane, Ann, Pete, Nick.

2 Fill in the blanks. Заповни пропуски.

- They
- He
- We
- He
- She



We are friends. _____ is my friend. _____ is my friend.



_____ is my friend. _____ are my friends.

3



Tick (✓) and write what you like.

Познач (✓) і напиши, що ти любиш.



books



bikes



dolls



cars

I like

4



Draw your mum or dad and write.

Намалюй своїх маму або тата і напиши.



This is my He/She is a

1  Tick (✓) and say what you have got in your classroom.
 Познач (✓) і скажи, що є в твоїй класній кімнаті.

We have got a



chair

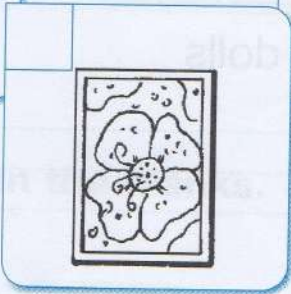

picture



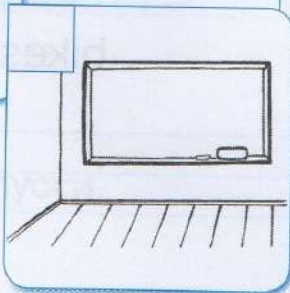

bin



blackboard



clock

2   Find the words, circle and copy.
 Знайди слова, обведи та перепиши.

tydoorthchairgclassroomdjhwindowdffloorkodesktablackboard

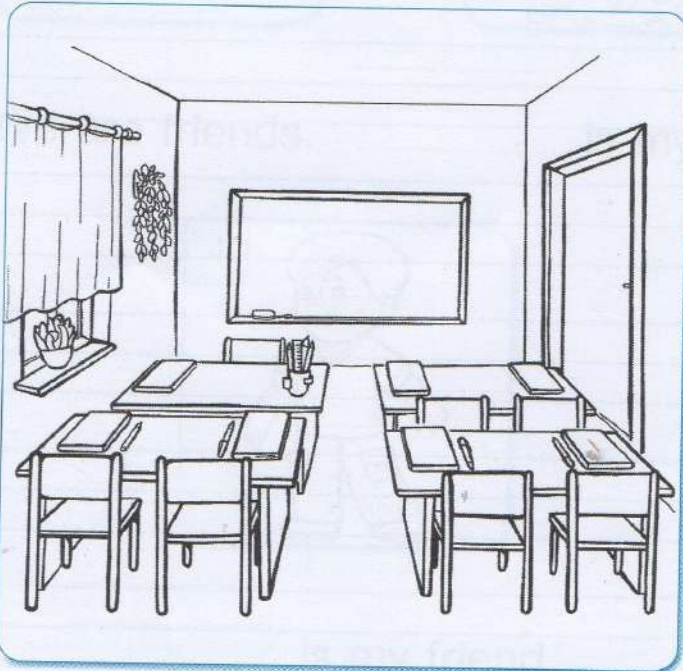

door

1



Read and draw. Прочитай і намалюй стрілки годинника.

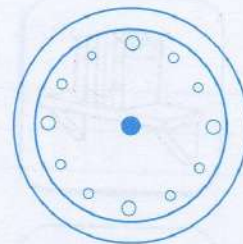
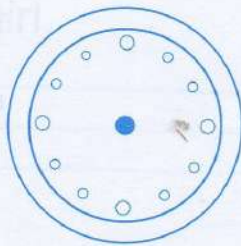

1 It's three o'clock.

2 It's five o'clock.

3 It's ten o'clock.

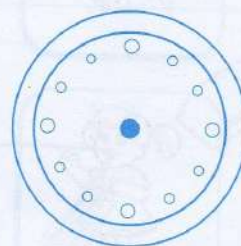
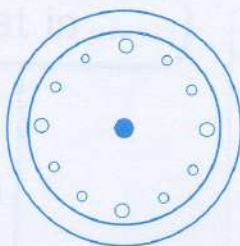
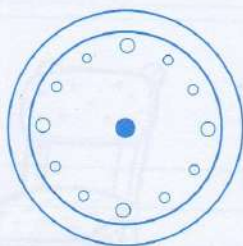

4 It's two o'clock.

5 It's six o'clock.

6 It's nine o'clock.

2



Trace, count and match.

Наведи, порахуй і з'єднай.

four

nine

six

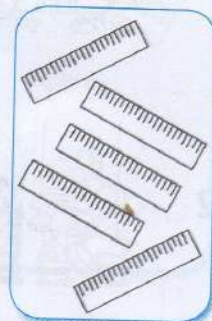
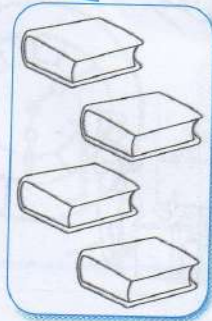
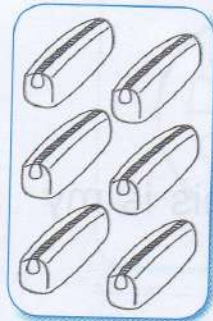
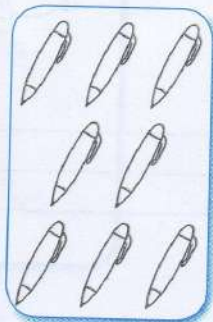
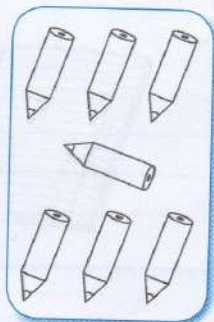
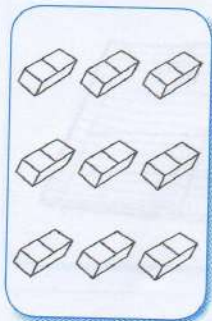

seven

five

eight

1



Match and write. З'єднай і напиши.

1



sh •

• sh

3



fi •

• e

3



sh •

• elf

2



Look and complete. Поглянь і допиши.

classroom school fly

1



I love my

2



This is my

3



My parrot can

1  **Сору.** Перепиши.

Classroom, teacher, boy, girl.

2  **Fill in the blanks.** Заповни пропуски.

1  That is

This is

This is a chair.

That is a table.

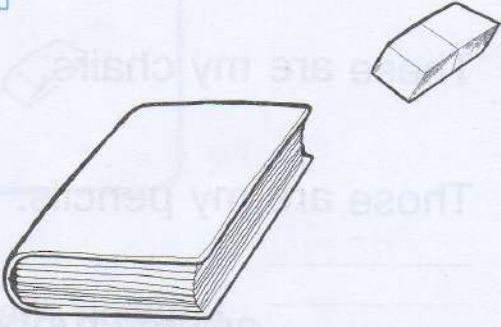
2 

_____ a rubber.

_____ a book.

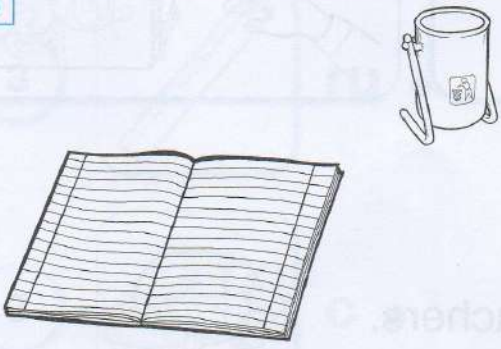
3 

_____ an exercise book.

_____ a bin.

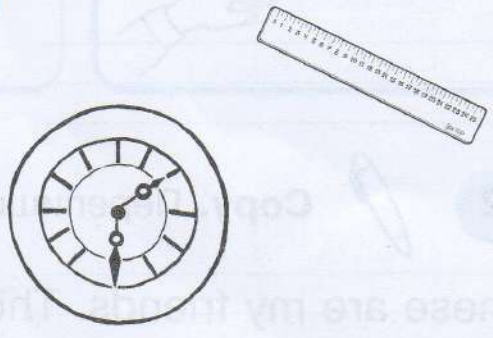
4 

_____ a clock.

_____ a ruler.

1  **Fill in the blanks. Заповни пропуски.**

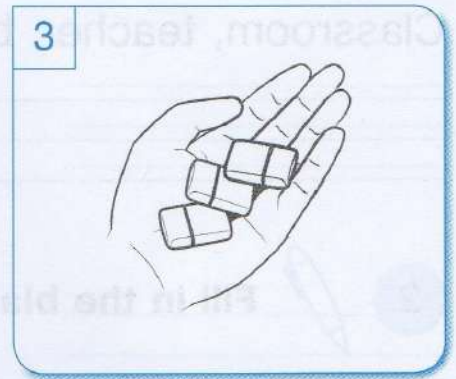
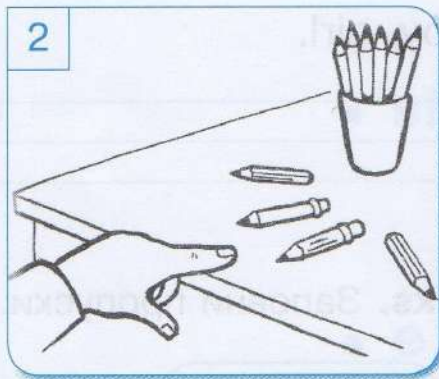
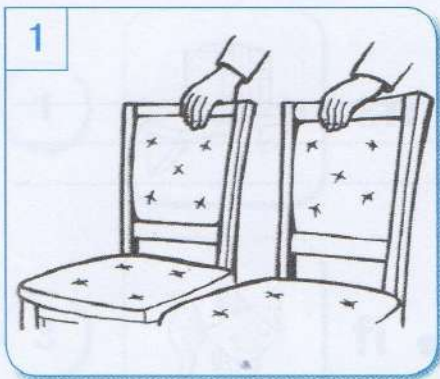

1 **These** are my chairs.

4 _____ are my books.

2 **Those** are my pencils.

5 _____ are my sharpeners.

3 _____ are my rubbers.

6 _____ are my pencil cases.

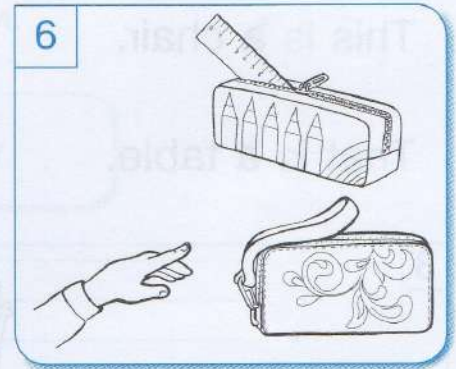
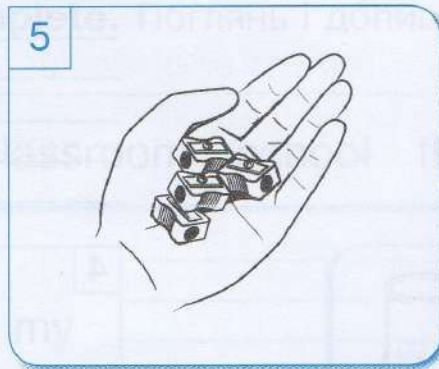
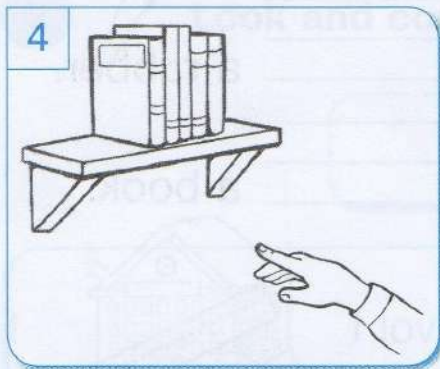

2  **Сору. Перепиши.**

These are my friends. Those are my teachers.

1  Circle the correct picture. Обведи відповідний малюнок.

-er

1



ar

2



-er

3



2  Match and write. З'єднай і напиши.

1



tea •

• ar

3



ru •

• tar

3



c •

• cher

4



s •

• ler

1  Copy. Перепиши.

Who are those? — They are Ben and Jane.

2  Read and circle. Прочитай та обведи.

- 1 — Where are they?
— **They / We** are in the garden.
- 2 — Where is he?
— **She / He** is in the house.
- 3 — Where are they?
— **They / I** are in the room.
- 4 — Where is she?
— **We / She** is in the classroom.



1



Fill in the blanks and number.
Заповни пропуски та пронумеруй.

This / These

That / Those

1

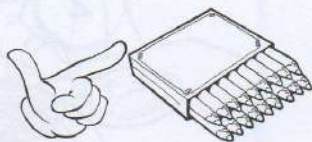

1 **These** are pencils.



2 _____ is a pencil case.



3 _____ are books.

4 _____ is a clock.

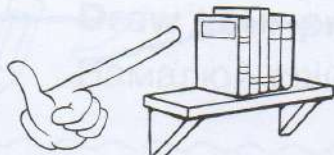

5 _____ are pictures.

6 _____ is an exercise book.

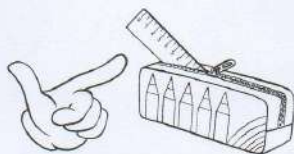

7 _____ is a bag.

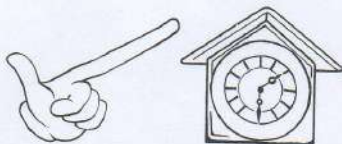

8 _____ are pencil sharpeners.

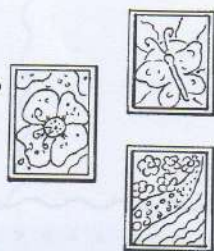
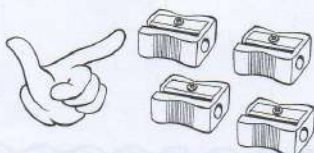

2 

Read and match. Прочитай і з'єднай.

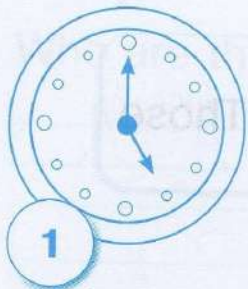

six o'clock



ten o'clock



seven o'clock



five o'clock

3 

Draw your classroom and say.

Намалюй свою класну кімнату та скажи.

We have got a blackboard...

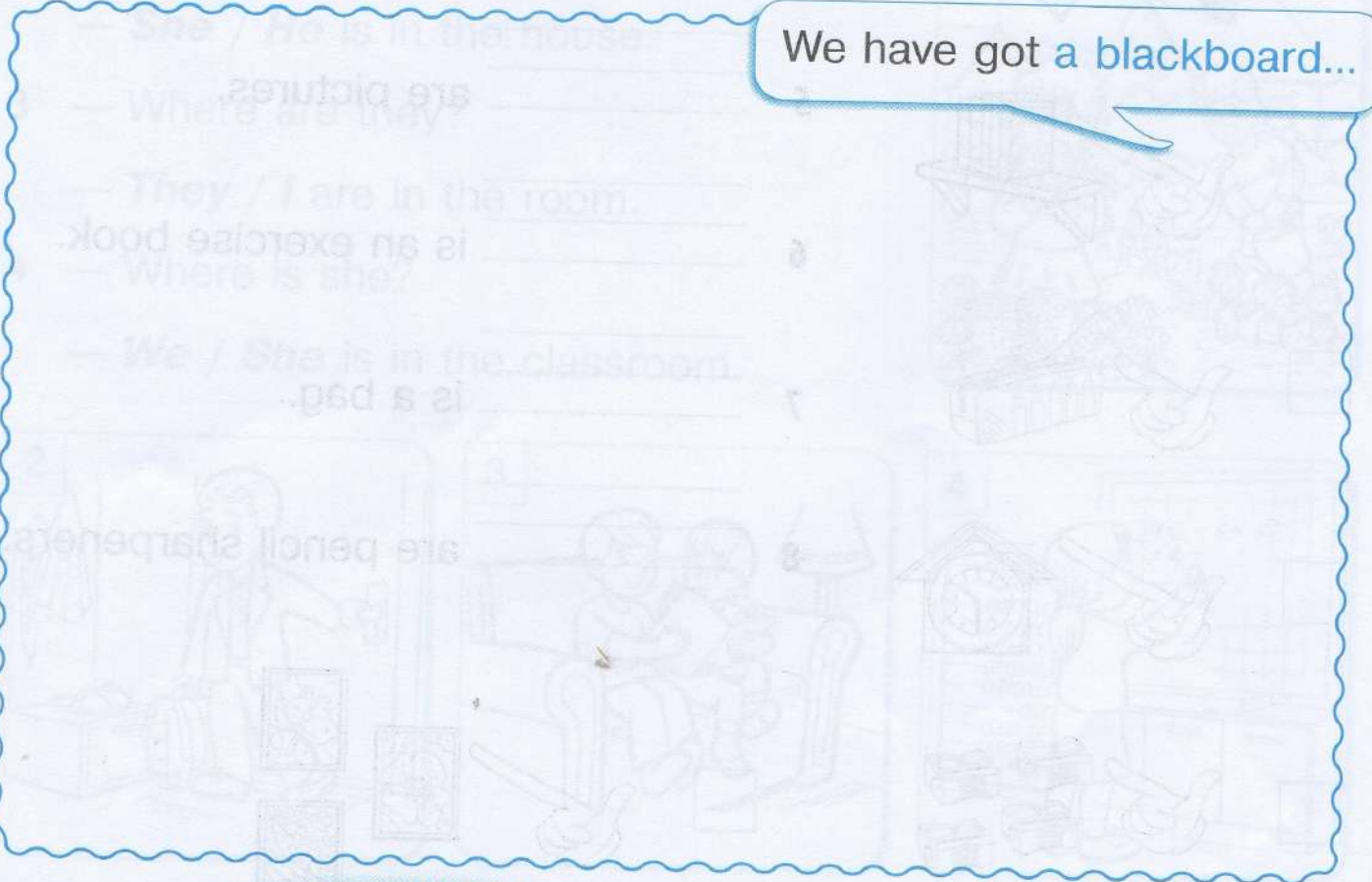

1



Match. Say which part of the day is now.

З'єднай. Скажи, яка зараз пора доби.



morning



dark



evening



noon

2



Draw your present mood and say.

Намалюй свій настрій і скажи.

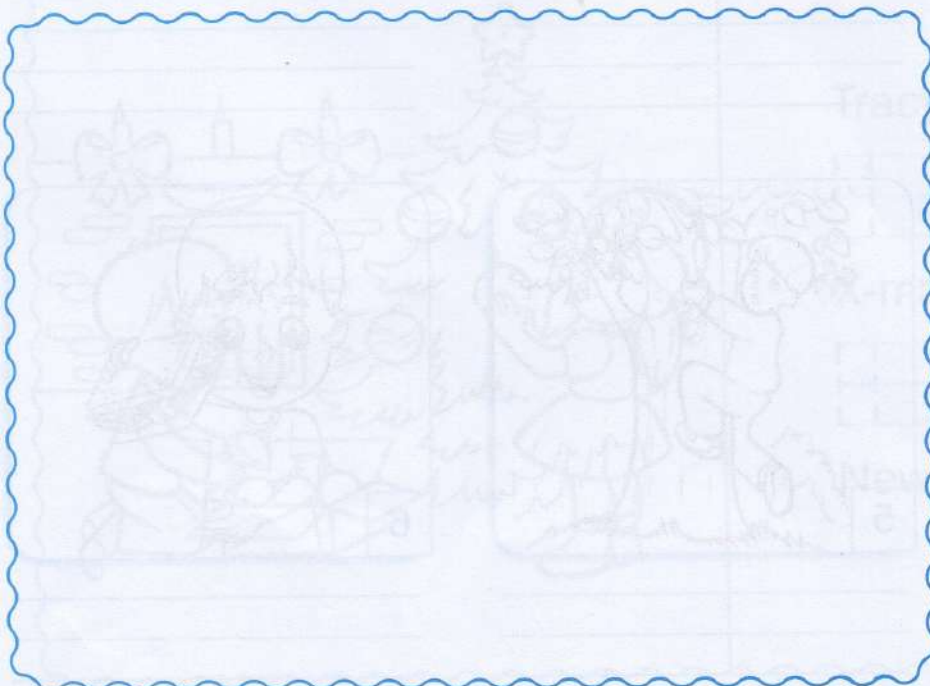

I am



1  **Сору. Перепиши.**

Hungry, tired, scared, hot, thirsty.

2  **Write and say. Напиши та скажи.**

- happy hungry scared funny thirsty sad

They are happy.



happy











1



Name and write. Назви та напиши.

mummy daddy family granny

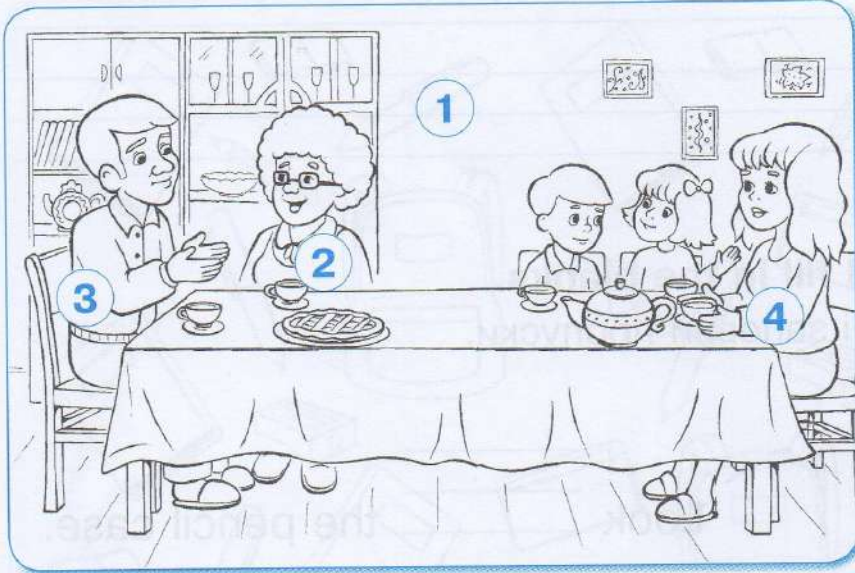

1 family

2

3

4

2



Colour the Christmas card and complete.

Розфарбуй різдвяну листівку та допиши.

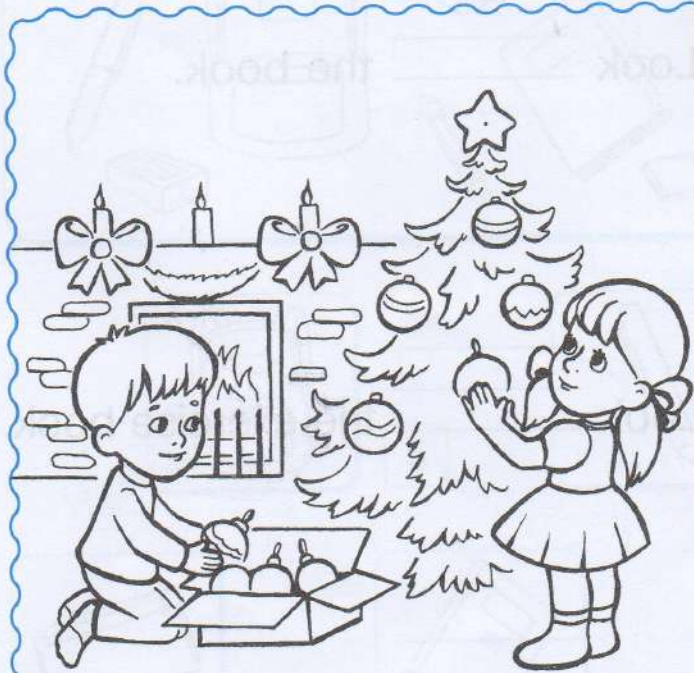

Tracy,

X-mas!

New Year!



1 **Сору. Перепиши.**

I can't find my pencil case. — Look on the desk.



2 **Join and fill in the blanks.**
З'єднай і заповни пропуски.



Look _____ the pencil case.



Look _____ the book.



Look _____ the exercise book.

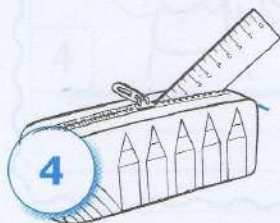

Look _____ the chair.

1



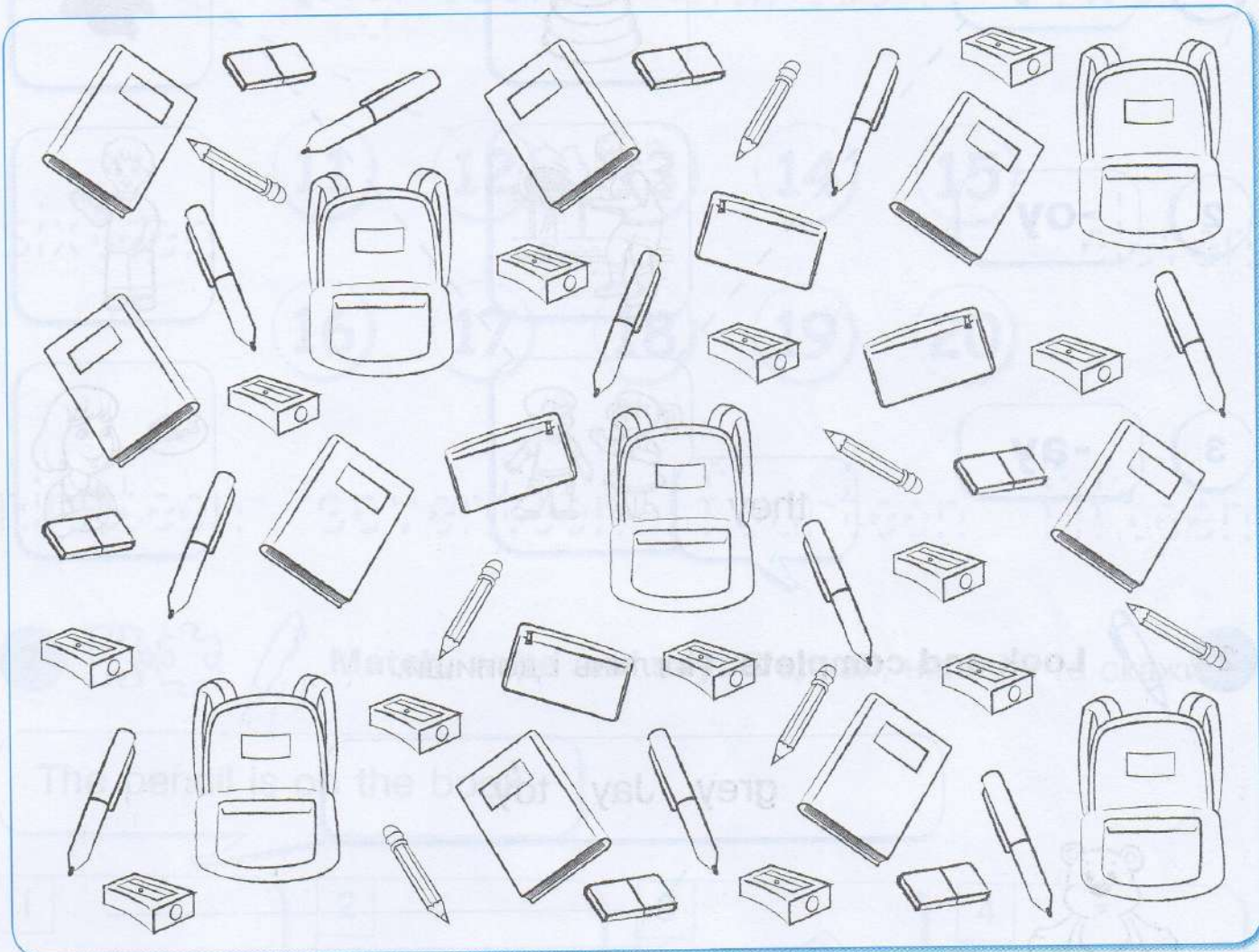

Count, write and say. Полічи, запиши та скажи.

I can find five bags.

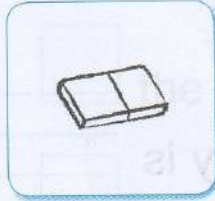
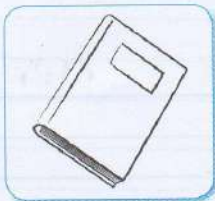
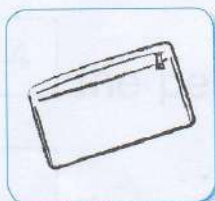
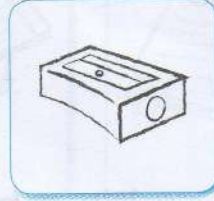

5



1  Match and say. З'єднай і скажи.

1 -ey



grey



2 -oy



3 -ay





they



2  Look and complete. Поглянь і допиши.

grey Jay toy

1  The baby has a _____.

2  It's a happy day for _____.

3  The sky is _____.

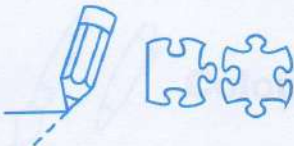
1  Trace and match. Наведи та з'єднай.

twelve eighteen thirteen twenty

sixteen 11 12 13 14 15 eleven

nineteen 16 17 18 19 20 fifteen

2  Match, write and say. З'єднай, напиши та скажи.

The pencil is on the book.

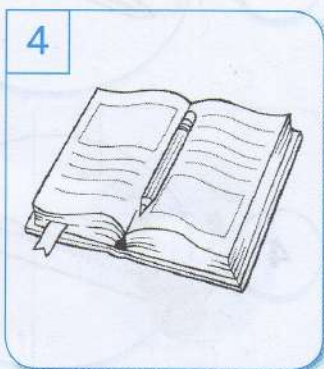
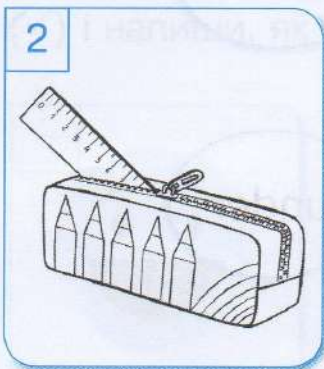
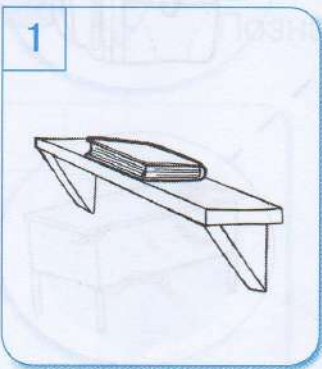

4 the pencil — _____

_____ the pen — _____







_____ the ruler — _____

_____ the book — _____

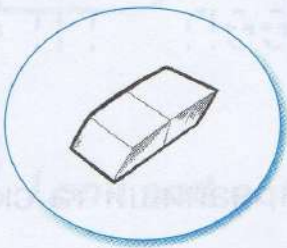
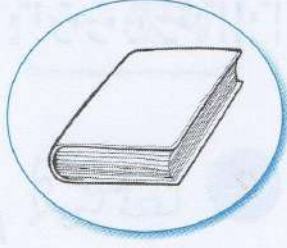
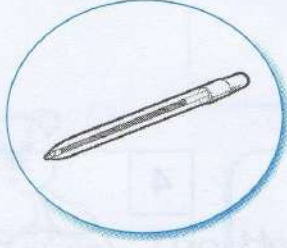

1 Read and match. Прочитай і з'єднай.

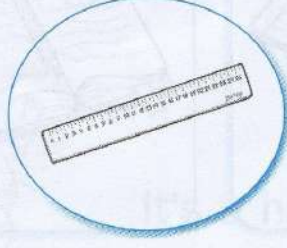
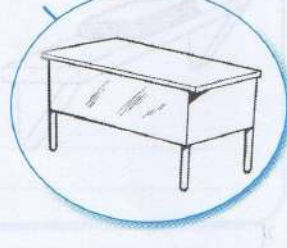
- 1 The book is on the table.
- 2 The rubber is under the pencil case.
- 3 The pen is in the bin.
- 4 The ruler is on the book.
- 5 The exercise book is in the bag.

1		on	
2		in	
3		under	
4			
5			

Note: Dashed lines connect the book in row 1 to the table in row 4, and the exercise book in row 5 to the backpack in row 3.



2 Colour and write. Зафарбуй і напиши.

11

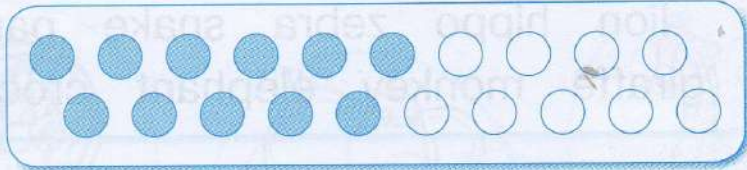

eleven

13

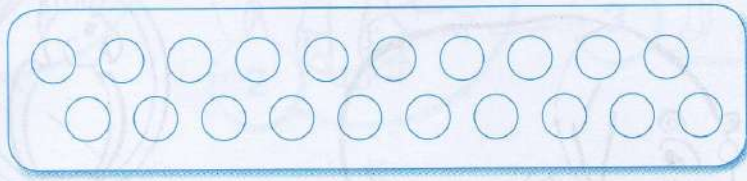

16



20

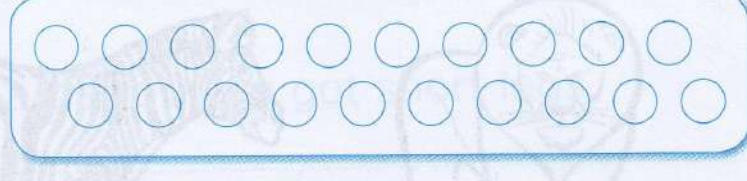



3 Tick (✓) and write how do you feel now.

Познач (✓) і напиши, як ти зараз почуваєшся.



tired

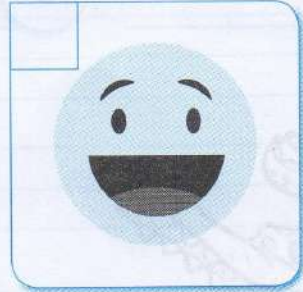

happy



sad

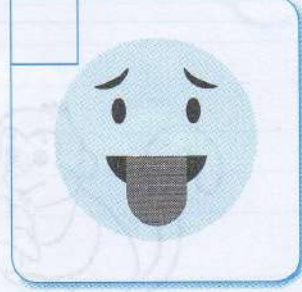

thirsty

I am _____

1



Look and write. Поглянь і напиши.

lion hippo zebra snake parrot
giraffe monkey elephant crocodile



1

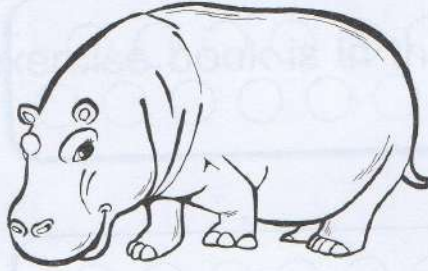

2



3

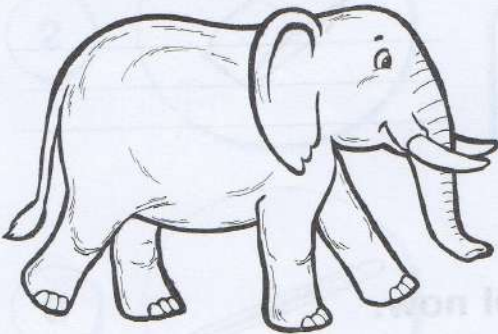

4



5

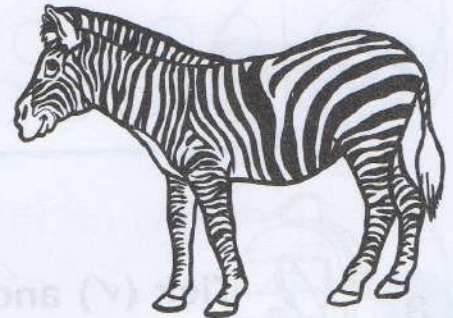

6



7

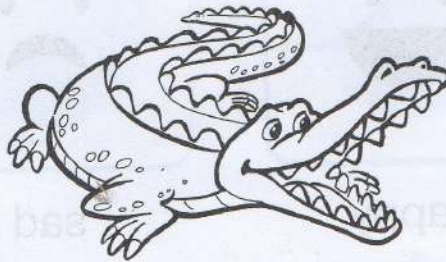

8

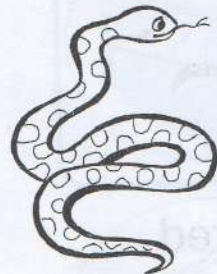

9



Match and write. З'єднай і напиши.

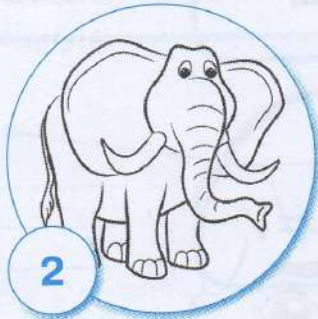

a big body

short legs

a long tail

a long neck

1 I'm a parrot. I've got short legs.

2 _____

3 _____

4 _____

5 _____

6 _____

7 _____

8 _____

1  Look and write. Поглянь і напиши.

1 **3** **th + ree =** _____

2  **mou + th =** _____

3  **too + th =** _____

2  Fill in the blanks. Заповни пропуски.



tooth



f _ _ t

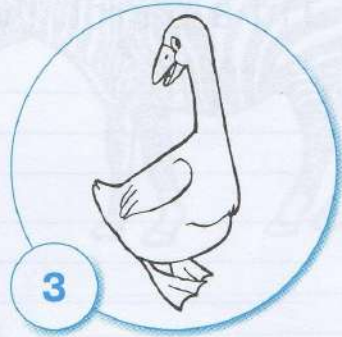

g _ _ se



t _ _ th

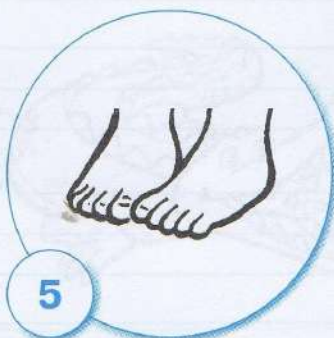

f _ _ t

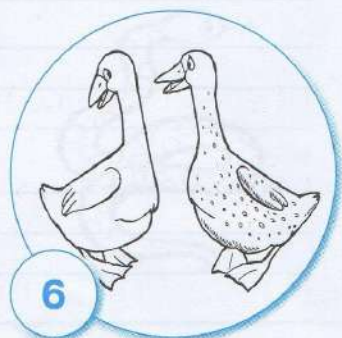

g _ _ se



1 Find, circle and write. Знайди, обведи та напиши.

rtyhairgdfkearsranfnoseanpnheadcgyeyesdpafmouththvb



2 Look and read. Tick (✓) true (T) or false (F).

Поглянь і прочитай. Познач (✓), які речення відповідають малюнку, а які — ні.

- | | T | F |
|---------------------------|--------------------------|--------------------------|
| 1 I have got long hair. | <input type="checkbox"/> | <input type="checkbox"/> |
| 2 I have got two noses. | <input type="checkbox"/> | <input type="checkbox"/> |
| 3 I have got a mouth. | <input type="checkbox"/> | <input type="checkbox"/> |
| 4 I have got big eyes. | <input type="checkbox"/> | <input type="checkbox"/> |
| 5 I have got six fingers. | <input type="checkbox"/> | <input type="checkbox"/> |
| 6 I have got two arms. | <input type="checkbox"/> | <input type="checkbox"/> |
| 7 I have got ten feet. | <input type="checkbox"/> | <input type="checkbox"/> |
| 8 I have got ten toes. | <input type="checkbox"/> | <input type="checkbox"/> |



1  **Read and match.** Прочитай і з'єднай.

- I've got one eye.
- I've got one nose.
- I've got short hair.
- I've got dark hair.

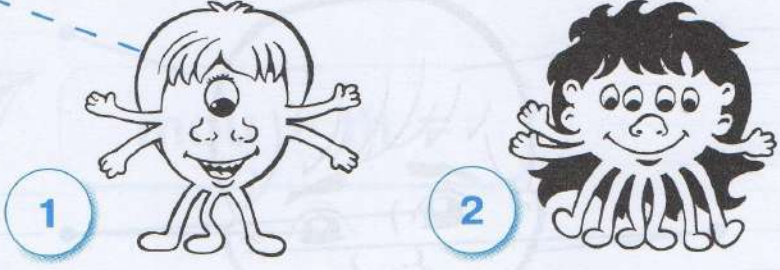

- I've got four arms.
- I've got three hands.
- I've got three legs.
- I've got six feet.

2  **Write answers.** Напиши відповіді.

- 1 How many fingers have you got?
I've got ten fingers.
- 2 How many hands have you got?

- 3 How many legs have you got?

- 4 How many necks have you got?

- 5 How many knees have you got?

1  Match and say. З'єднай і скажи.

1 **g**

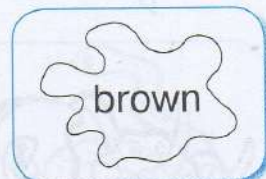

2 **ph**

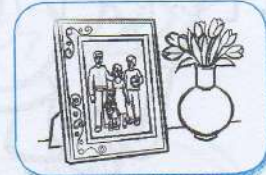

3 **ou**



4 **ow**



2  Read and match. Прочитай і з'єднай.



1 It is big and green.
It has got big teeth.
It can swim.



2 It is small and white.
It has got two small legs.
It can fly and talk.

3 It is small and brown.
It has got a long tail.
It can jump.



4 It is big and grey.
It has got small eyes
and ears. It can run.

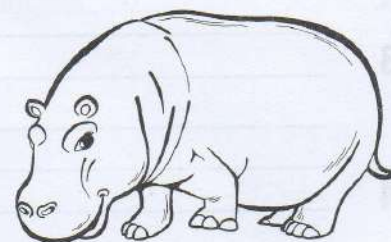

1



Count and write. Полічи та запиши.

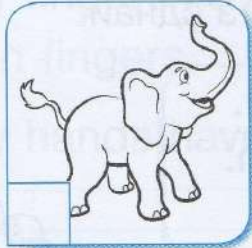
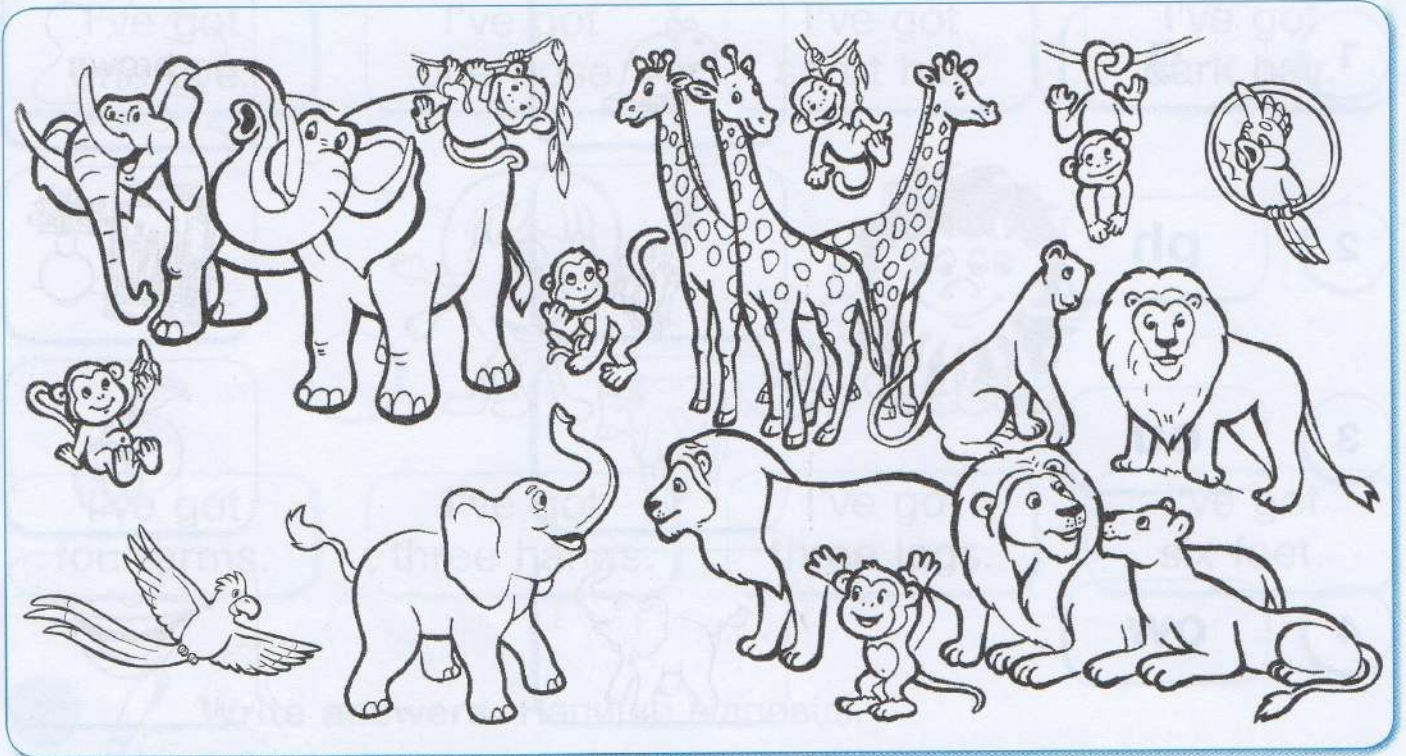

1 I can see three giraffes.

2 _____

3 _____

4 _____

5 _____

1  Do the crossword 'Animals'. Розгадай кросворд «Тварини».



1



2

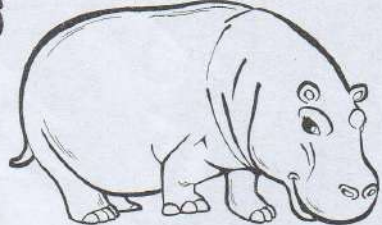

3

1		A				
2		N				
3		I				
4		M				
5		A				
6		L				
7		S				



7

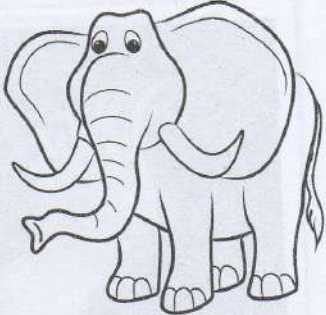

6



4



5

2  Read and draw a girl's face. Прочитай і намалюй обличчя дівчинки.

- She has got a small face.
- She has got brown hair.
- She has got green eyes.
- She has got small ears.
- She has got a small nose.
- She has got a red mouth.

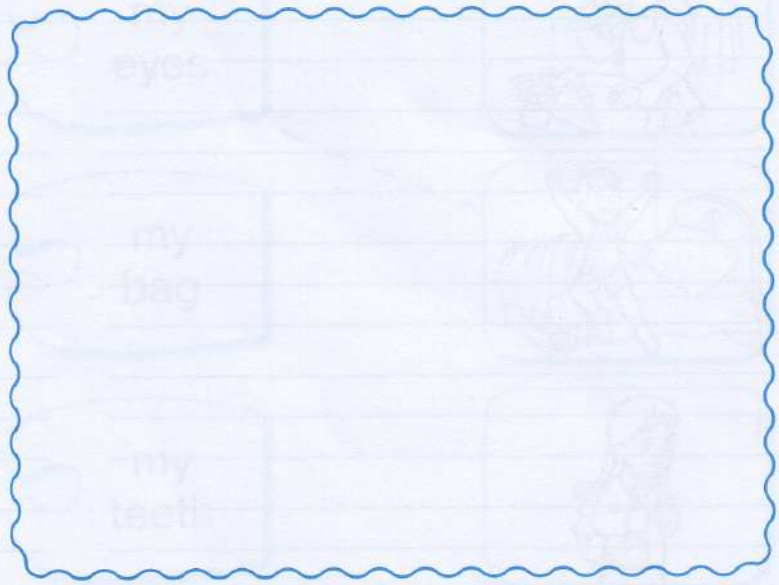

3



Look and write.

Поглянь і напиши.

This is an elephant. It is grey. It has got a long nose and big ears. It can walk. It cannot fly.

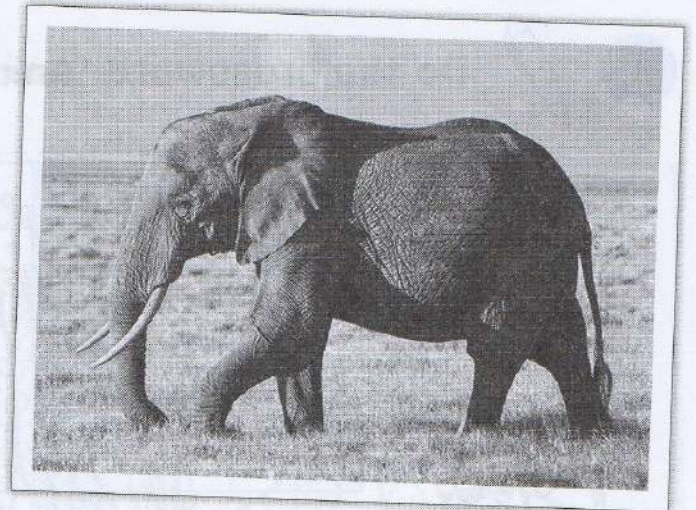

1



Make up words and write. Утвори слова та напиши.



cloesth



cefa

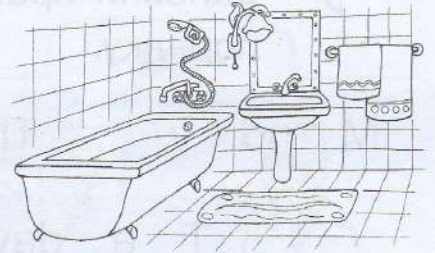

baumthro

clothes

2



Read and match. Прочитай і з'єднай.

1

open

my clothes



2

clean

my face



3

take

my eyes



4

wash

my bag



5

put on

my teeth



1  **Fill in the blanks. Write days of the week in the correct order.**
 Заповни пропуски. Напиши назви днів тижня у правильному порядку.

M _ n d _ y

Th _ r _ day

S _ n _ ay



F _ _ day

T _ e _ day

We _ ne _ day

Sa _ u _ day

Monday,

2   **Join and write. З'єднай і напиши.**

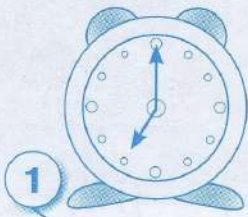

1



2



3



4

go home

catch the bus

have lunch

wake up

1 It's seven o'clock. I wake up.

2

3

4

1 Circle the correct picture. Обведи відповідний малюнок.



ea-

1

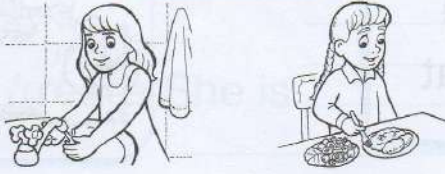

2

-ea-

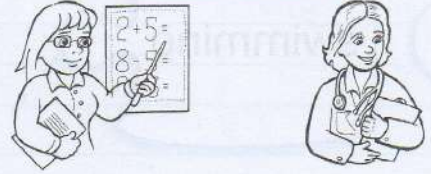

-ng

3

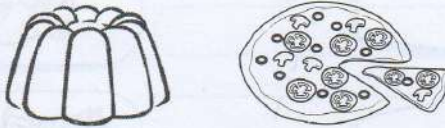

4

-ng

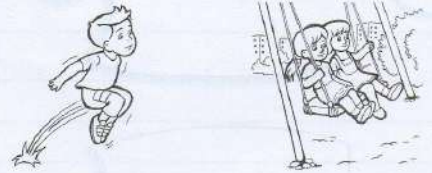

2



Match and write. З'єднай і напиши.

wash

clean

drink

eat

read

tea

book

pudding

face

teeth

1 Wash your face.





2

3

4

5

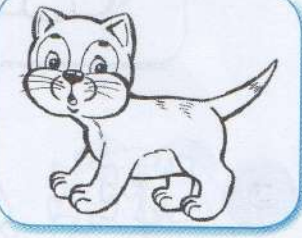
1  Read and match. Прочитай і з'єднай.

1	swimming	-	like a bat	
2	sleeping	-	like a fish	
3	flying	-	like a cat	
4	walking	-	like a bear	

2  Copy. Перепиши.

I'm playing with a dog.

I'm jumping like a frog.

1  **Make up sentences and write. Number.**
 Утвори речення та напиши. Пронумеруй.

1 I / play I am playing.

2 She / read She is

3 He / swim

4 I / sleep

5 She / walk

6 She / eat

7 He / jump

8 He / sing

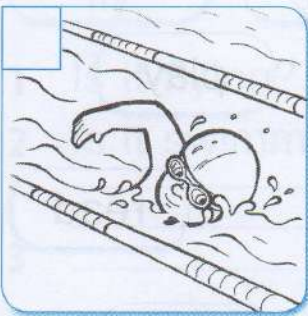



1

Fill in the blanks and match.

Заповни пропуски та з'єднай.

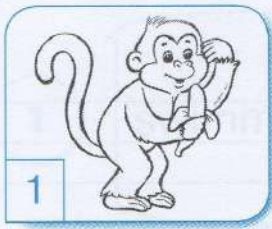

1



2



3



4

br_ther

t_lk

m_nkey

t_ll

b_ll

sm_ll

w_lk

m_ther

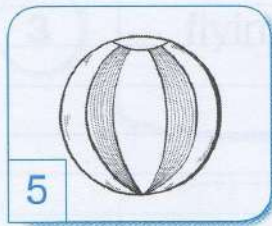

5



6



7

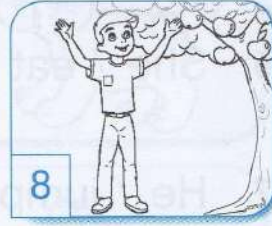

8

2



Make up words and fill in the blanks.

Утвори слова та заповни пропуски.

This is my family. I'm (1) playing with a car. My

mum is (2) _____ a book. My dad is

(3) _____ a sandwich. My granny is

(4) _____ on a chair. My brother is

(5) _____ with a cat. My sister is

(6) _____ a cake.

cut

play

read

eat

play

sit

1



Look and complete. Поглянь і допиши.

swim

run

fly

jump



1 The frog is jumping.



3 The zebra _____

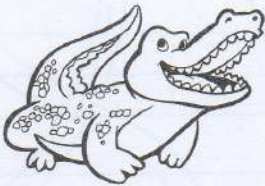

2 The crocodile _____



4 The parrot _____

2



Look and write. Поглянь і напиши.

1



fly

2



swim

3



jump

4



talk

5

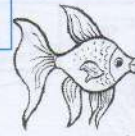

swim

6



walk

1 Is it flying? — Yes, it is.

2 Is it swimming? — No, it isn't.

3

4

5

6

1



Find and circle days of the week. Write them.

Знайди й обведи назви днів тижня. Напиши їх.

t	s	a	t	u	r	d	a	y	a	s
g	h	j	k	z	x	c	v	b	n	m
w	d	f	g	h	s	u	n	d	a	y
e	q	w	e	r	t	y	u	i	o	p
d	a	m	o	n	d	a	y	k	d	t
n	f	g	h	j	k	l	z	x	c	u
e	v	b	n	m	o	i	u	y	t	e
s	r	t	h	u	r	s	d	a	y	s
d	e	w	q	l	k	j	h	g	f	d
a	s	d	f	r	i	d	a	y	z	a
y	h	j	z	x	c	v	b	n	m	y

2



Read and match. Прочитай і з'єднай.

1

Is he fishing?

A

No, it isn't.

2

Is it flying?

B

She is sleeping.

3

What are you doing?

C

Yes, he is.

4

What is she doing?

D

I'm reading.



3 Join and write. З'єднай і напиши.



1



2

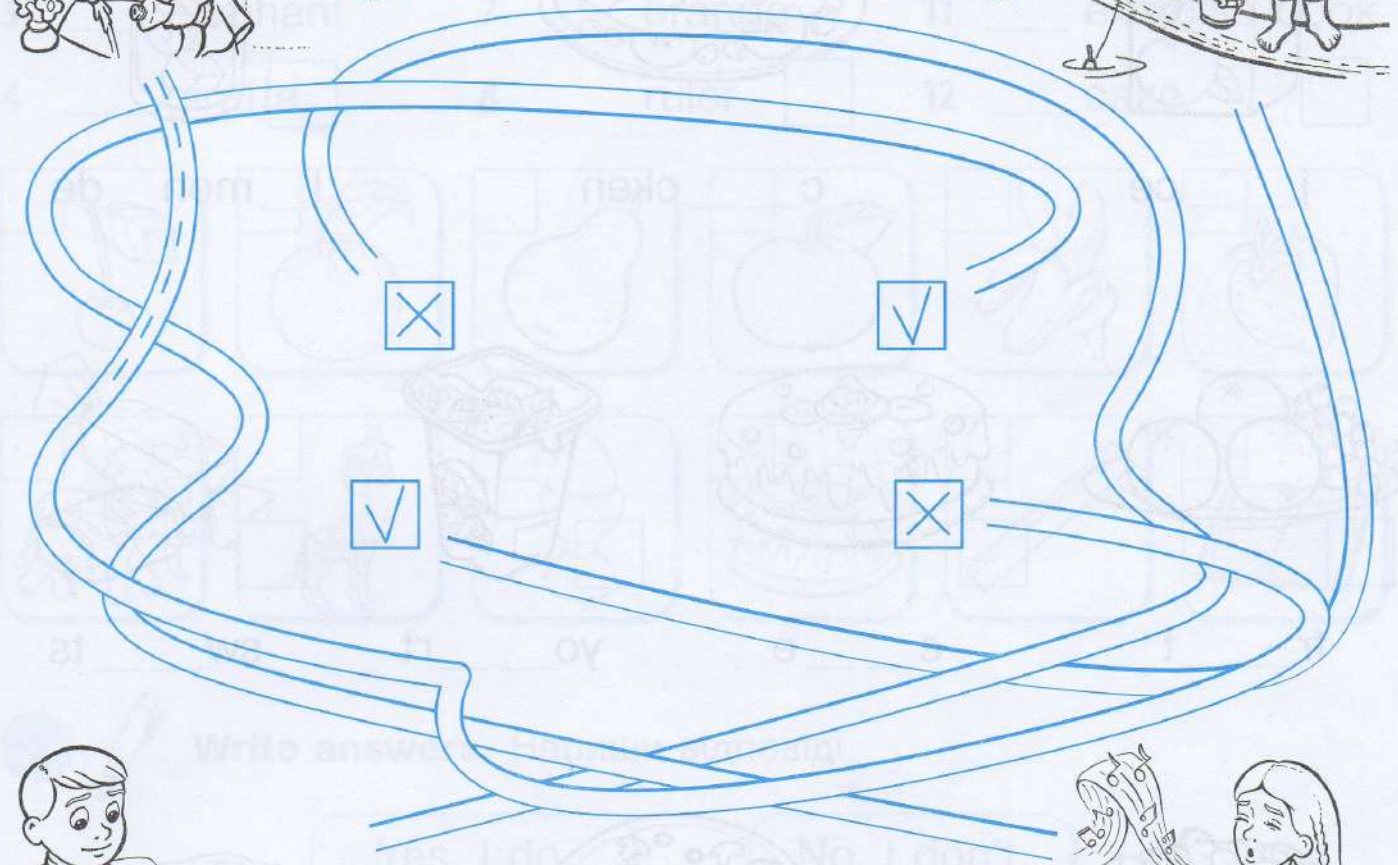

3



4

1 Is she cleaning teeth? — No, she isn't.

2 _____

3 _____

4 _____

1



Fill in the blanks. Tick (✓) what you like. Complete the sentence. Заповни пропуски. Познач (✓), що тобі подобається. Допиши речення.

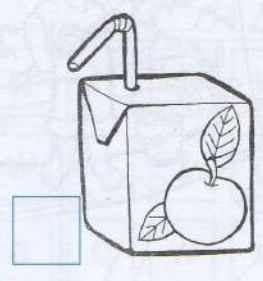

j _ _ ce

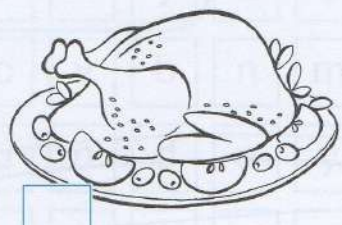

c _ _ cken



l _ mon _ de



fr _ _ t

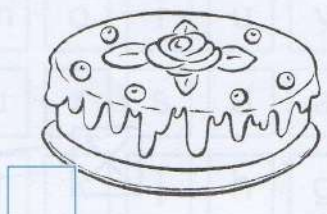

c _ _ e



yo _ _ rt

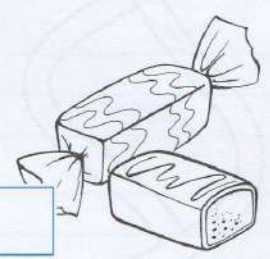

sw _ _ ts



s _ la _ _

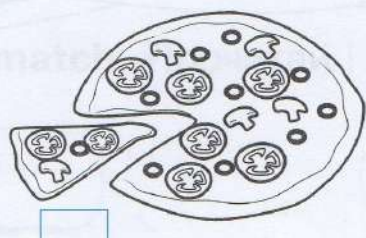

pi _ _ a

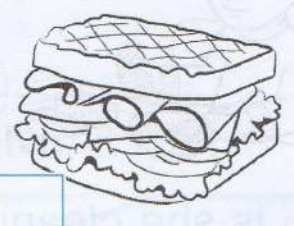

s _ _ dw _ ch

I like



1 Fill in the blanks and number.

Заповни пропуски та пронумеруй.

a

an

- | | | |
|----------------|--------------|----------------------|
| 1 an egg | 5 ___ apple | 9 ___ pear |
| 2 ___ banana | 6 ___ cherry | 10 ___ strawberry |
| 3 ___ elephant | 7 ___ orange | 11 ___ exercise book |
| 4 ___ giraffe | 8 ___ ruler | 12 ___ cake |

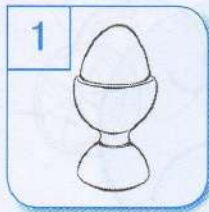
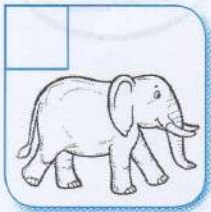

2 Write answers. Напиши відповіді.

Yes, I do.

No, I don't.

1 Do you like salad?

4 Do you like bananas?

2 Do you like lemonade?

5 Do you like pizza?

3 Do you like apples?

6 Do you like sweets?

1





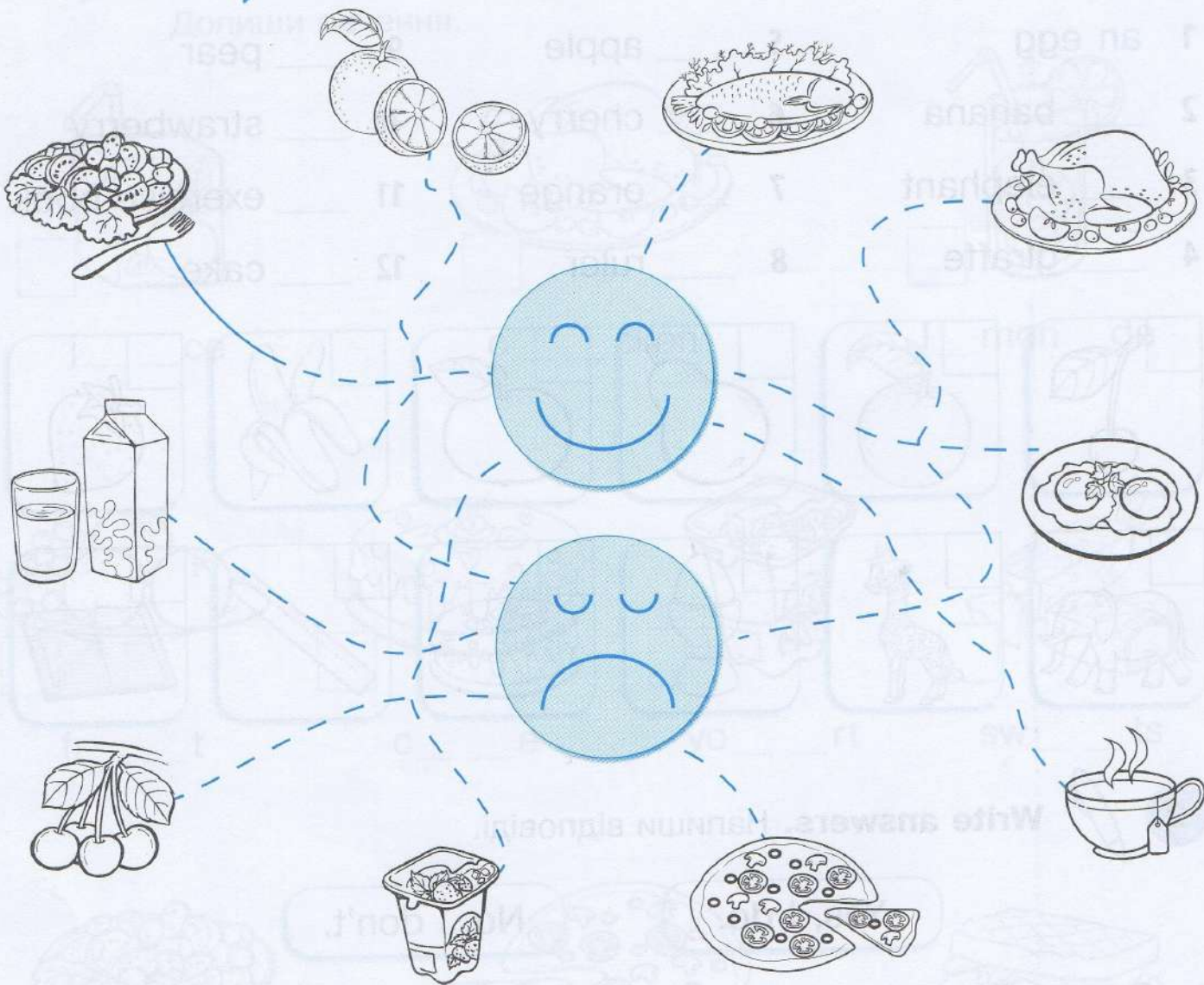





Join and complete. З'єднай і допиши.

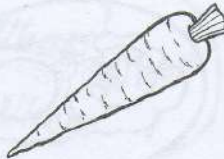

I like

I don't like

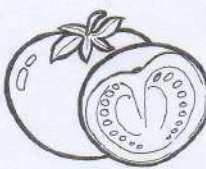
1  Fill in the table. Заповни таблицю.

Fruit	Vegetables
 pear	
	
	
	
	

2  Fill in the blanks. Заповни пропуски.

- tomatoes
- some
- yes
- no
- banana
- are
- orange

— Hello! Can I have (1) some milk?
 — Hello! Here you (2) are.
 — Thank you! Can I have eight (3) bananas.
 — (4) Yes, here you are.
 — Thanks! Can I have a (5) potato and an (6) orange?
 — Sorry, (7) no fruit.



1



Join and write. З'єднай і напиши.

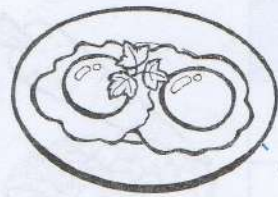

Breakfast

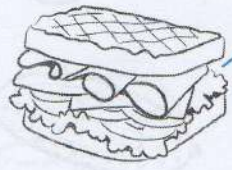

Lunch

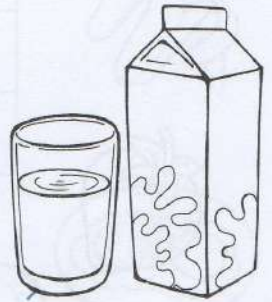

Dinner



I eat a sandwich for breakfast.

I drink

1  Read and circle. Прочитай та обведи.

- 1 **What / When** is that?
- 2 **Where / When** is your home?
- 3 **When / What** do you get up?
- 4 **What / When** is your surname?
- 5 **What / Where** do you like for dinner?
- 6 **What / Where** are my socks and trainers?



2  Write answers. Напиши відповіді.



1 What do you like for breakfast?

2 What do you like for lunch?

3 What do you like for dinner?

1  Complete. Допиши.

- | | |
|---------------------------|-----------------------|
| 1 I like — he likes _____ | 4 I sleep — Ann _____ |
| 2 I write — she _____ | 5 I eat — mum _____ |
| 3 I read — Tom _____ | 6 I drink — dad _____ |

2   Join and write. З'єднай і напиши.

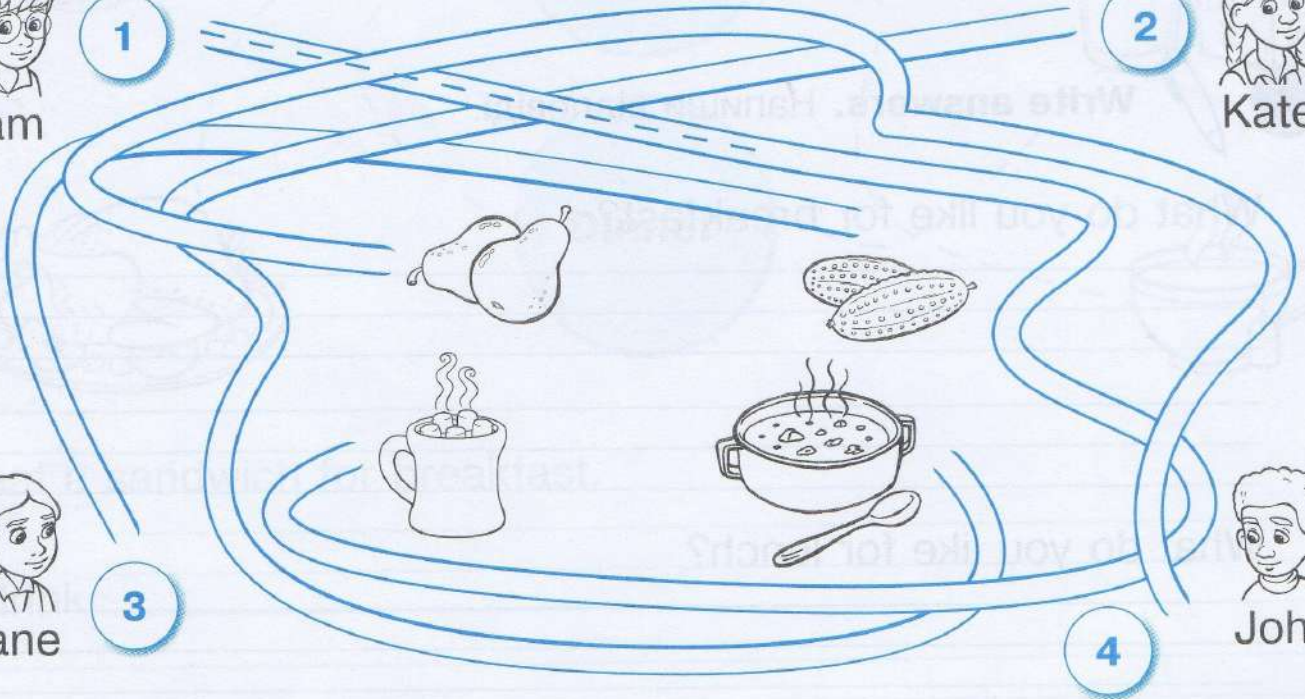

1 Sam likes hot chocolate.

- 2 _____
- 3 _____
- 4 _____

1  Read and number. Прочитай і пронумеруй.

- | | | | | |
|----------|----------|----------|------------|-------------|
| 1 cheese | 2 tomato | 3 yogurt | 4 cherries | 5 ice cream |
| 6 bread | 7 egg | 8 fish | 9 salad | 10 mushroom |
| 11 tea | 12 juice | 13 pizza | 14 chicken | 15 sandwich |































2  Circle the odd one out. Обведи зайве в кожному рядку.

1 apple cucumber banana orange

2 strawberry tomato carrot pepper

3 milk tea salad hot chocolate

4 fish chicken egg lemonade

3



Join and write. З'єднай і напиши.

1 She likes ice cream. She doesn't like carrots.

2 _____

3 _____

4 _____

1



Make up words and write. Number.
Утвори слова та напиши. Пронумеруй.

ummers

1

utumna

2

interw

3

prings

4

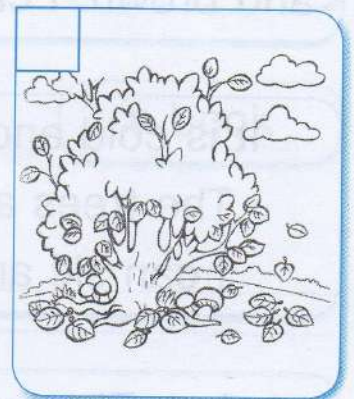
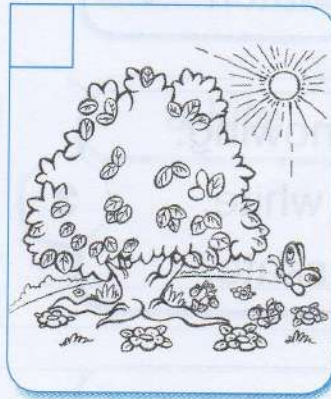
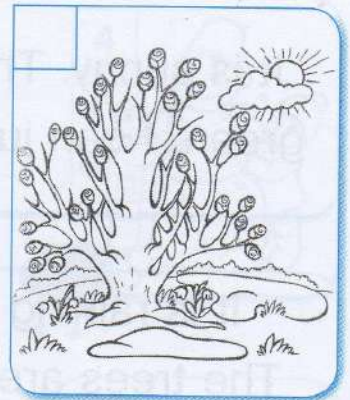

2



Look and complete. Поглянь і допиши.

1 It is snowing.



2 It is _____

3 It is _____



4 It is _____

1  Read and match. Прочитай та з'єднай.

It is sunny. The trees are green. I can jump and run.

1

A



It is winter.

It is raining and cold. The trees are yellow, red and brown. I can watch TV.

2

B



It is spring.

It is cold and snowing. The trees are white. I can ski and skate.

3

C



It is summer.

It is hot. The trees are green. I don't go to school. I can swim and ride a bike.

4

D



It is autumn.

2  Write what the weather is today. Use the example.

Напиши про сьогоднішню погоду за зразком.

It is raining today. I can stay at home and drink some tea.



1 Match and write. З'єднай і напиши.



2



3



4



make

fly

read

ride

a bike

a snowman

a kite

a book

1 It is hot. I can fly a kite.

2 _____

3 _____

4 _____



2 Write your answers. Напиши свої відповіді.

What season do you like? What can you do?

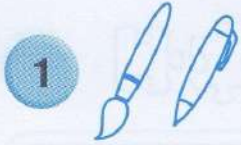

1 Colour and fill in the blanks. Complete the sentences.
 Розфарбуй і заповни пропуски. Допиши речення.

His trainers are red.



_ra_n_rs



j__ns

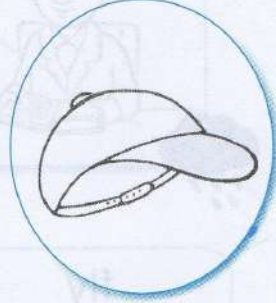

c_p



_ac__t



d__s__



s__da_s



T__h__rt



sh_r_s

His

Her



1 Read, number and colour.
Прочитай, пронумеруй і розфарбуй.

- 3 I'm wearing a red dress. I'm wearing green shorts.
- I'm wearing blue jeans. I'm wearing a yellow T-shirt.

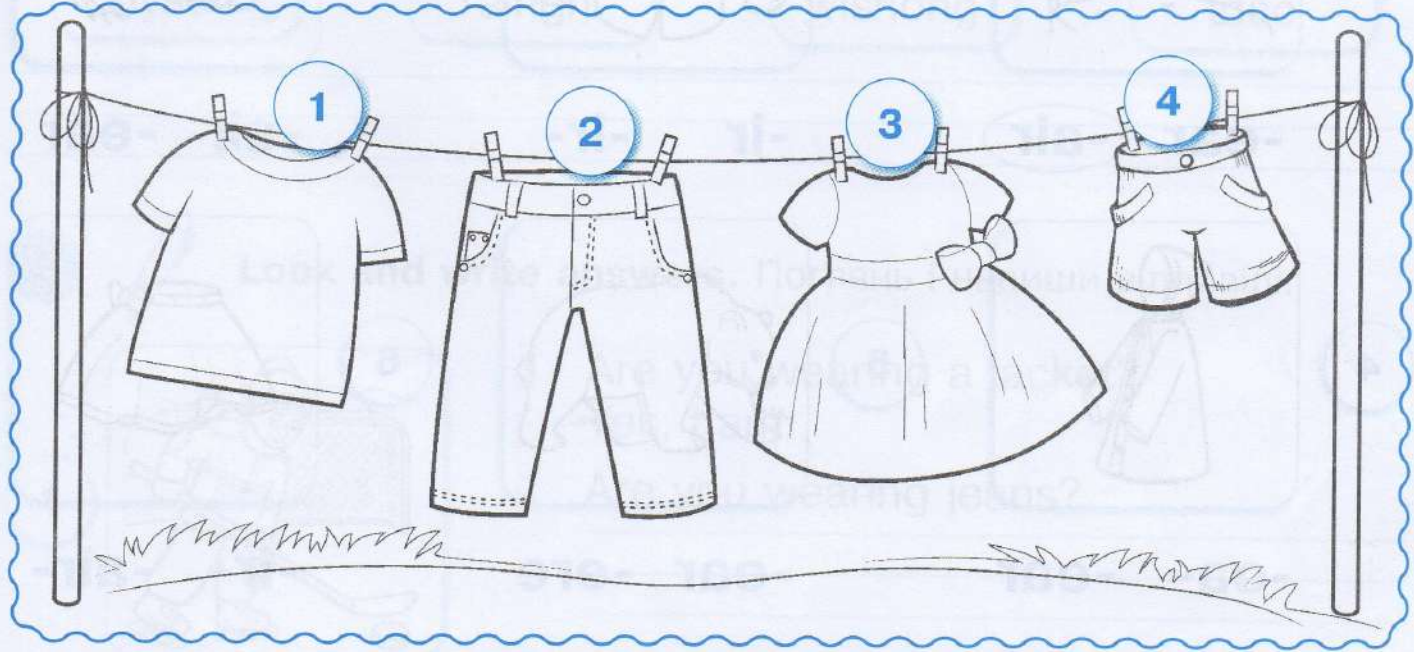

2 Draw and write what you are wearing today.
Намалюй і напиши, у що ти одягнений/одягнена.



I'm wearing _____



1 Circle the correct letters. Обведи правильні літери.



-ear -air

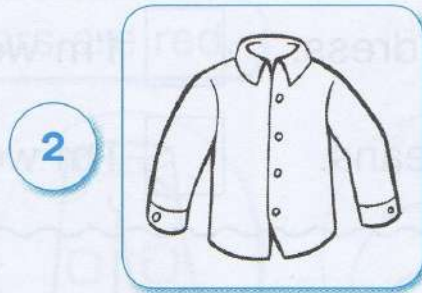

-ir -ir-

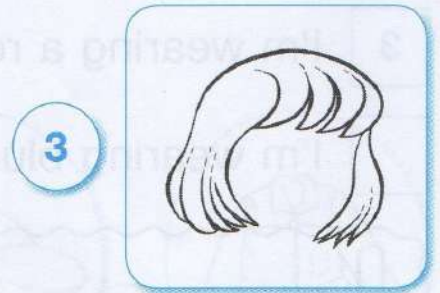

-air -ear



-oa- -ear

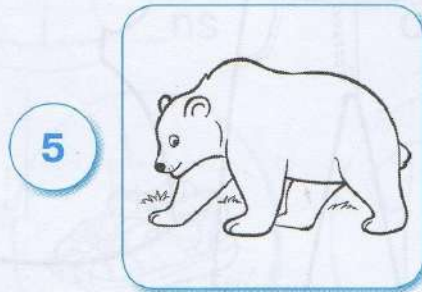

-ear -ere

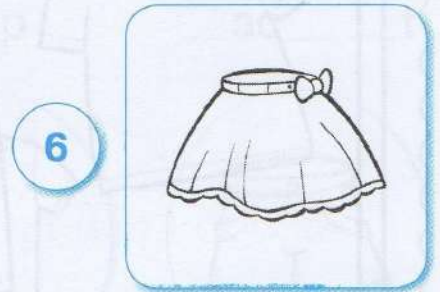

-ir- -air-



2 Look and read. Tick (✓) true (T) or false (F).

Поглянь і прочитай. Познач (✓), які речення відповідають малюнкам, а які — ні.

T F

- | | | |
|----------------------------|--------------------------|--------------------------|
| 1 He is wearing sandals. | <input type="checkbox"/> | <input type="checkbox"/> |
| 2 She is wearing a skirt. | <input type="checkbox"/> | <input type="checkbox"/> |
| 3 He is wearing a T-shirt. | <input type="checkbox"/> | <input type="checkbox"/> |
| 4 She is wearing shorts. | <input type="checkbox"/> | <input type="checkbox"/> |
| 5 He is wearing trousers. | <input type="checkbox"/> | <input type="checkbox"/> |
| 6 She is wearing socks. | <input type="checkbox"/> | <input type="checkbox"/> |



1  **Make up words and write.** Утвори слова та напиши.



nysun



raingni



wisnong



ldco

2  **Look and write answers.** Поглянь і напиши відповіді.



1 Are you wearing a jacket?
Yes, I am.

2 Are you wearing jeans?

3 Are you wearing a skirt?



4 Are you wearing shorts?

5 Are you wearing sandals?



4



5



1  **Circle the odd one out.** Обведи зайве в кожному рядку.

1 raining spring winter summer

2 hot cold raincoat sunny

3 shoes cap boots sandals

4 shirt skirt trousers autumn

2  **Look and complete as in the example.**
Поглянь і допиши за зразком.

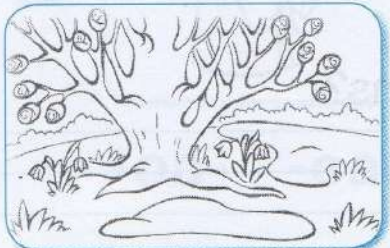

1 It is spring. I'm wearing a jacket and jeans.



2 _____

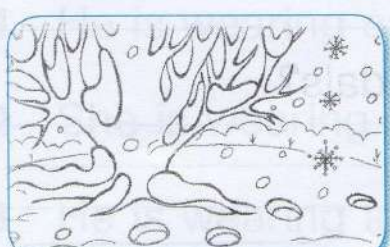

3 _____



4 _____

3



Read and circle. Прочитай та обведи.

- 1 Summer is my favourite **season** / **weather**.
- 2 It is **hot** / **cold** in winter.
- 3 The trees are yellow, red and brown in **autumn** / **spring**.
- 4 It is **raining** / **snowing**. We can make a snowman.
- 5 It's raining today. I'm putting my **raincoat** / **jacket** on.

4



Draw your favourite season. Write 3-4 sentences about it. Намалюй свою улюблену пору року. Напиши 3-4 речення про неї.

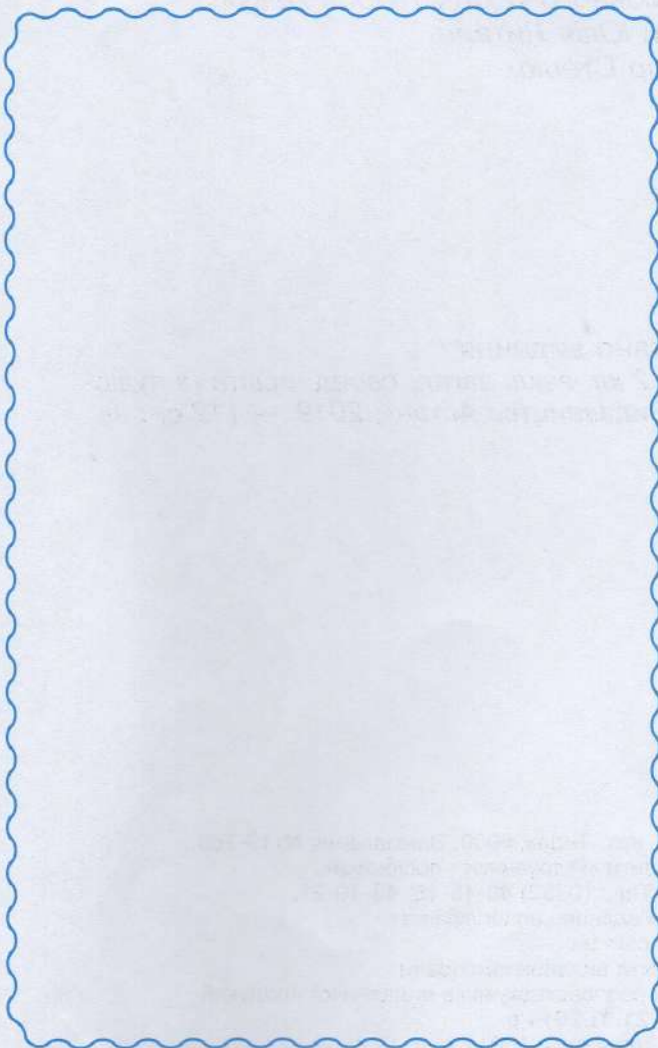

Horizontal lines for writing 3-4 sentences about the favorite season.