

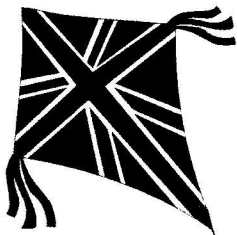

English

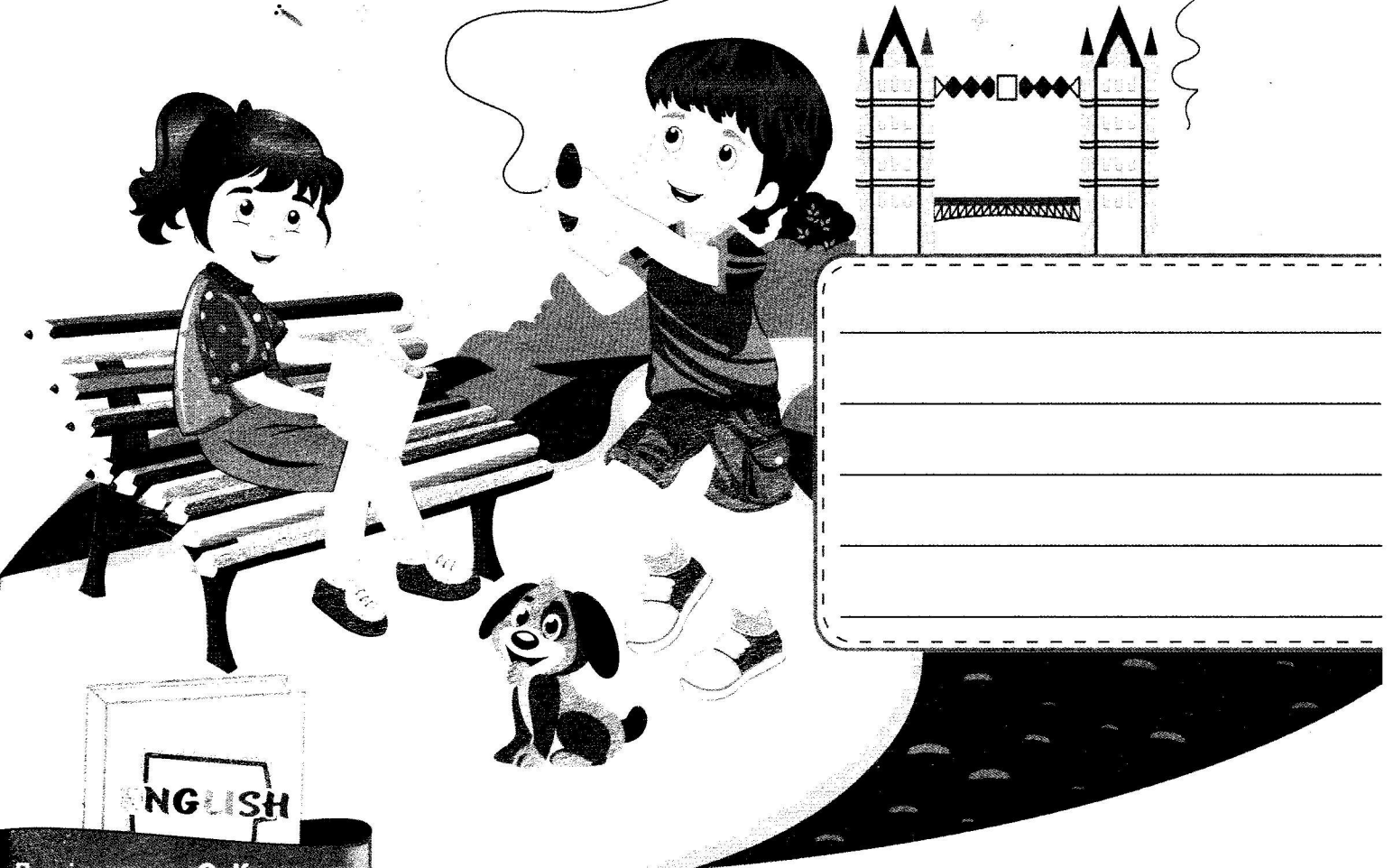

Workbook

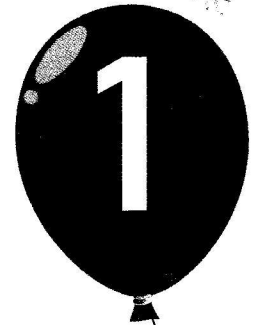

До підручника О. Карлюк
за програмою О. Савченко
за програмою Р. Шияна

Оксана Косован
Надія Вітушинська

АНГЛІЙСЬКА МОВА

Робочий зошит для 1 класу закладів загальної середньої освіти

(до підручника О. Карпюк)



Тернопіль
Видавництво «Підручники і посібники»
2021

Trace and say. Наведи та скажи.

Hello!

I am smiling Sam.

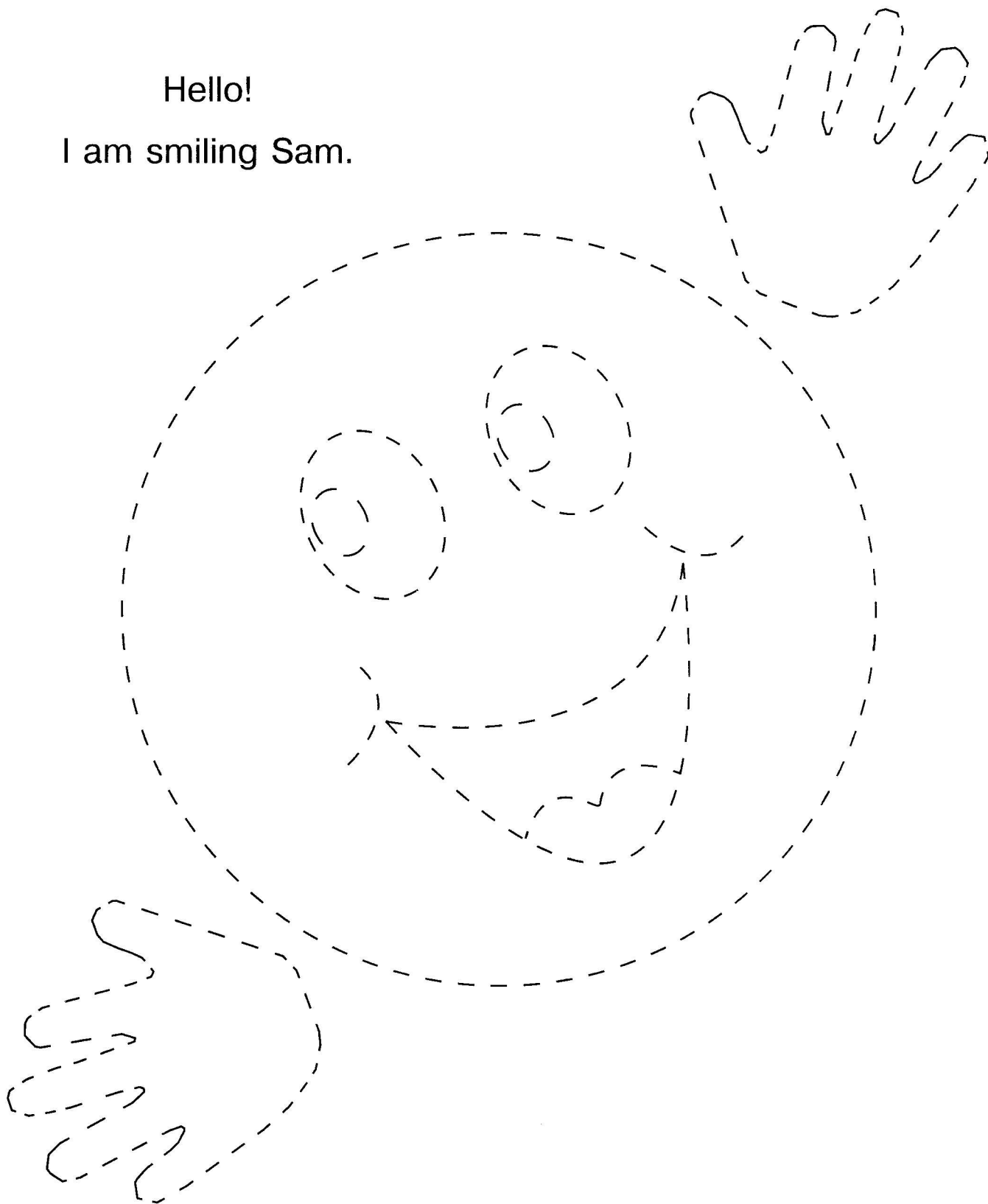

Colour and say. Розфарбуй і скажи.

Hello, I'm



Draw yourself and say. Намалюй себе та скажи.

Hello,
I am

Join and say. З'єднай і скажи.

What is your name?

My name is

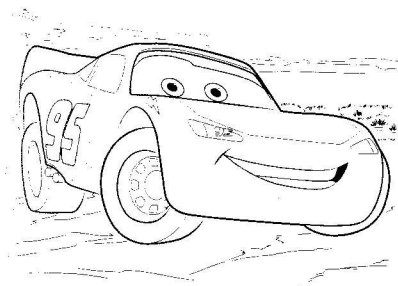
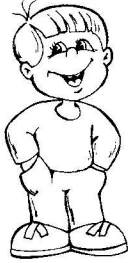

Match and say. З'єднай і скажи.

Hello!

Goodbye!

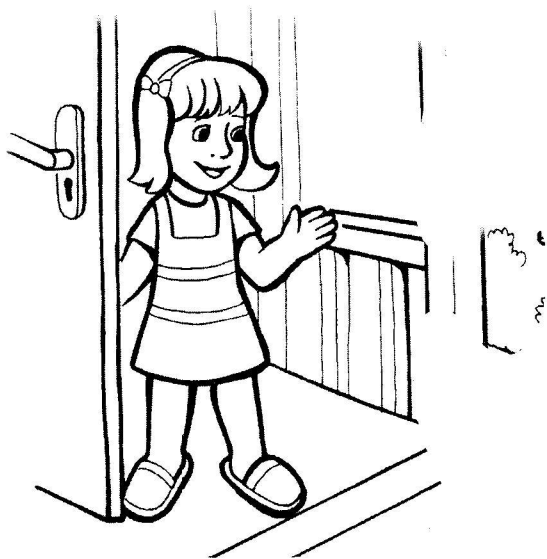

Colour and say. Розфарбуй і скажи.

Hi!
How are you?

I am fine.
Nice to meet you.





Find, trace in different colours and say.

Знайди, наведи різними кольорами та скажи.

A book.

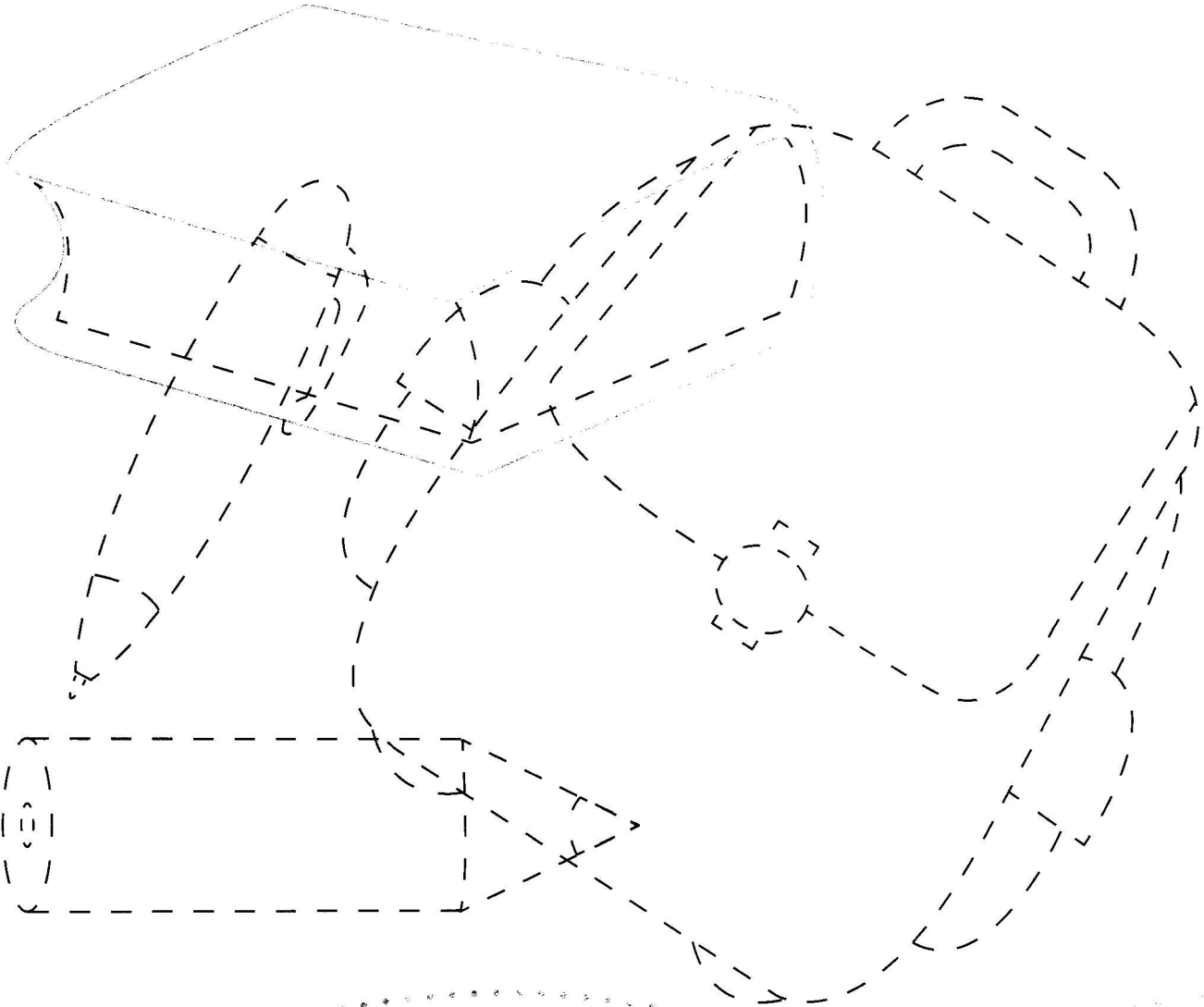
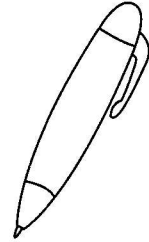
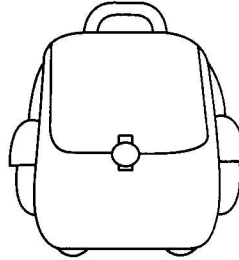
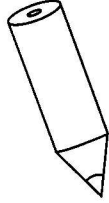
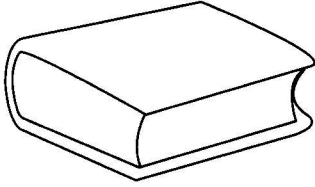

Find, circle and say. Знайди, обведи та скажи.

It's a book.

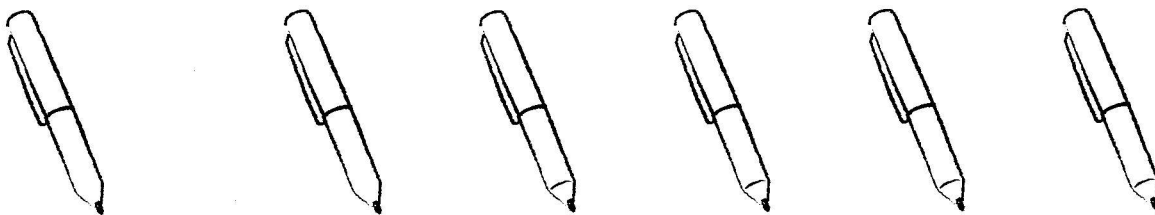
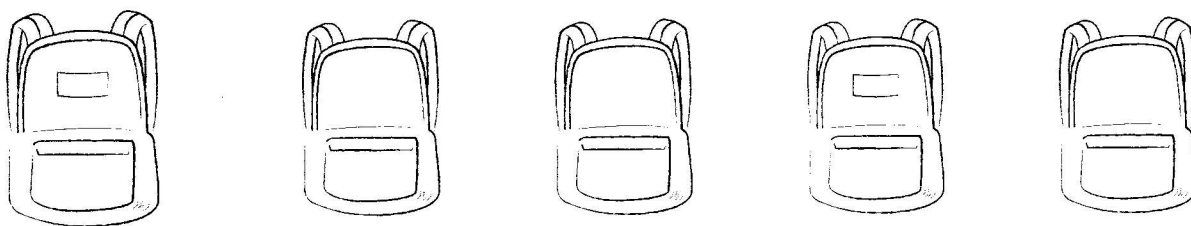
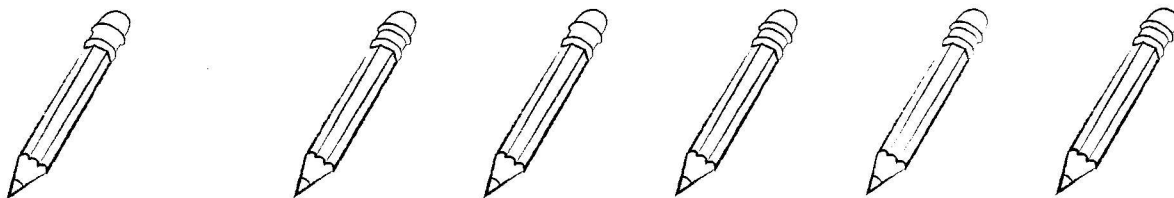
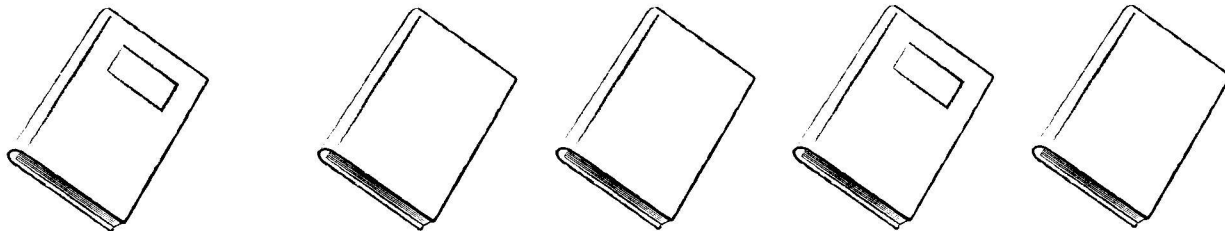

Match and say. З'єднай і скажи.

It's a

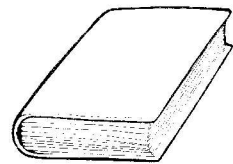
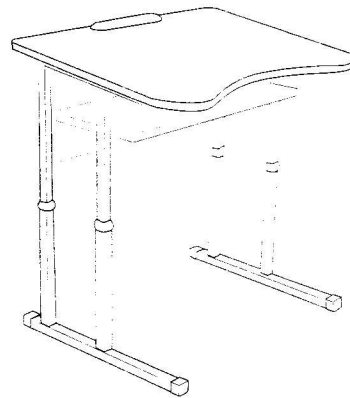
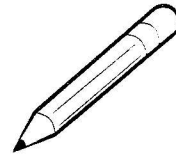
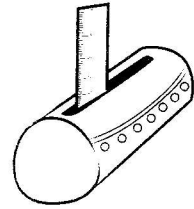
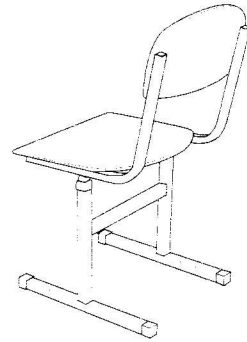
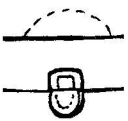
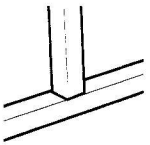
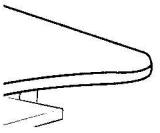
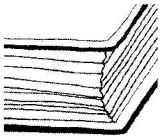

Join, tick and say. З'єднай, познач і скажи.

Is it a ... ?

No, it isn't. / Yes, it is.

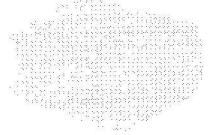
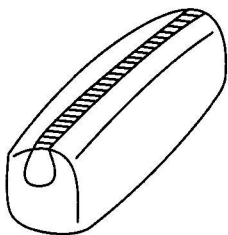
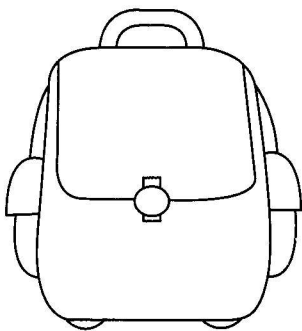
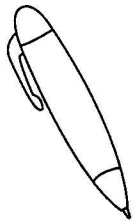
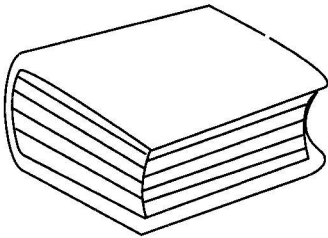



Join and say. З'єднай і скажи.

What is it?

It's a

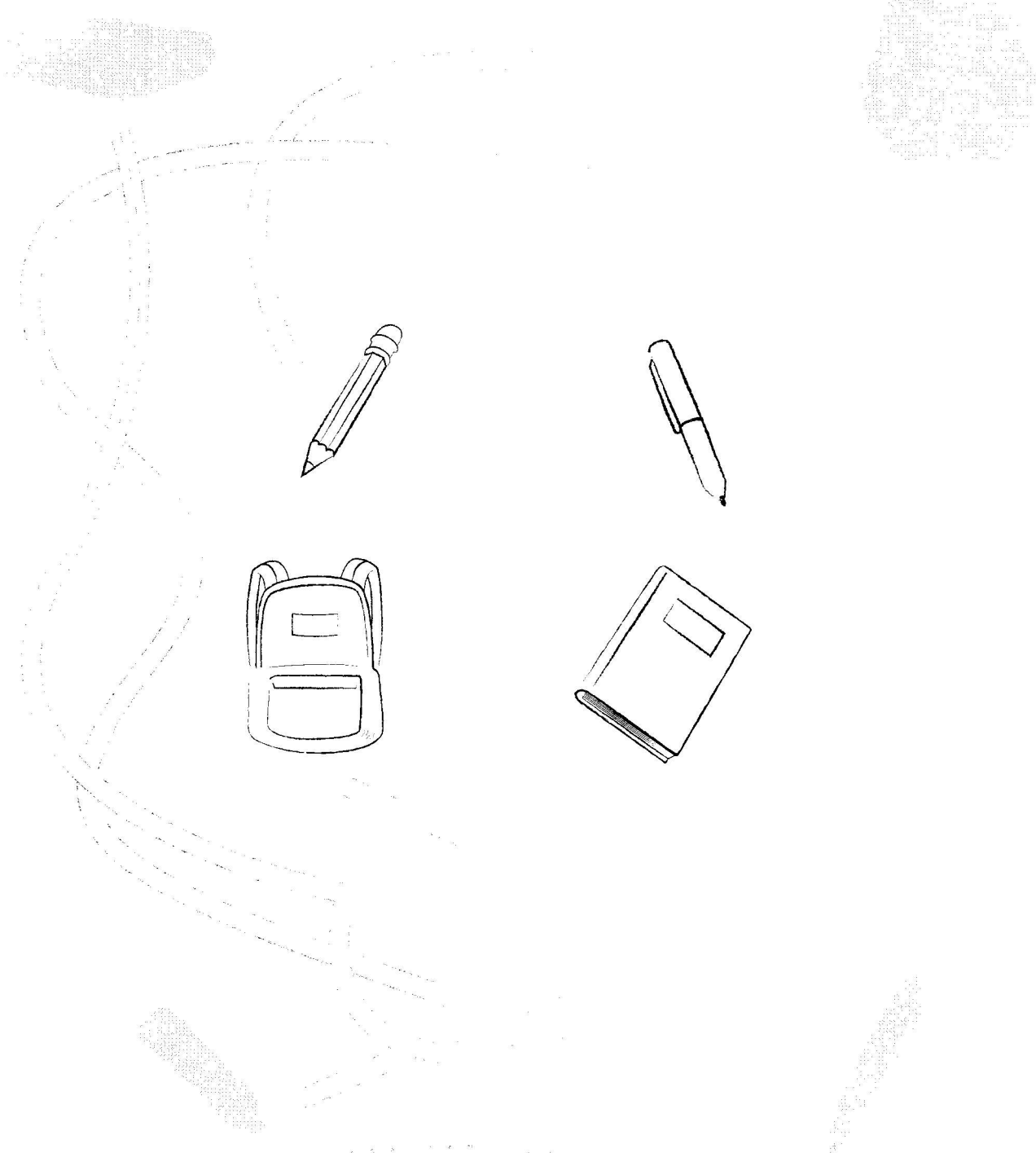

Circle the correct number and say.

Обведи відповідну кількість і скажи.

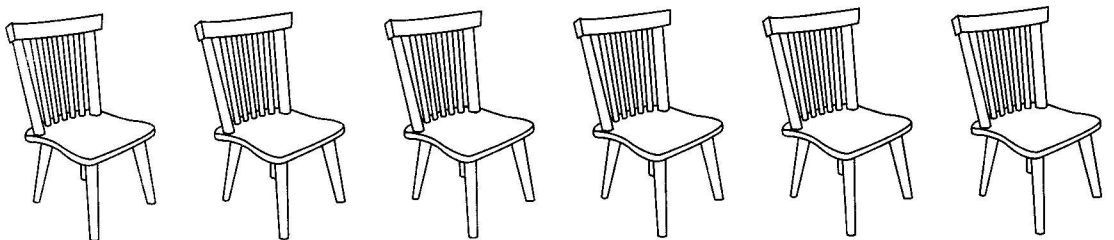
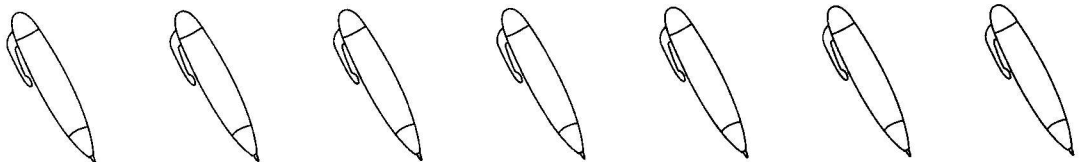
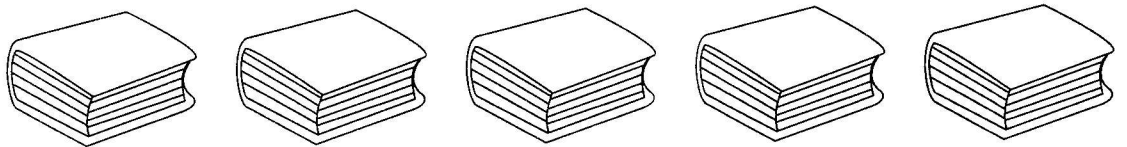
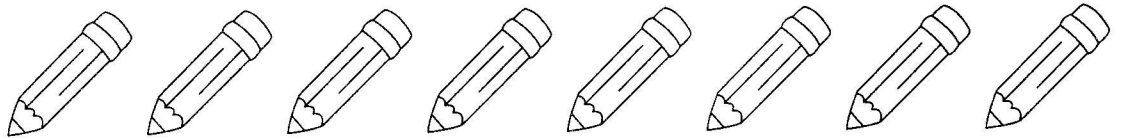
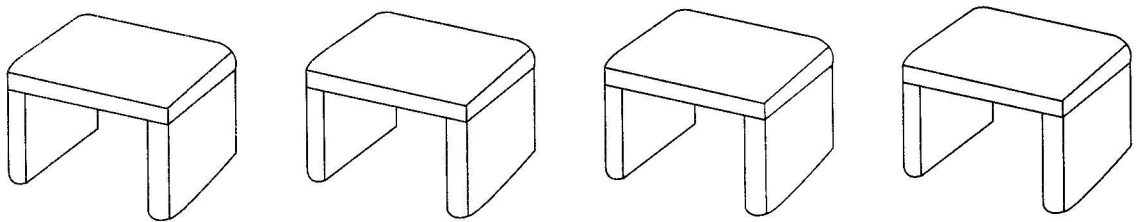
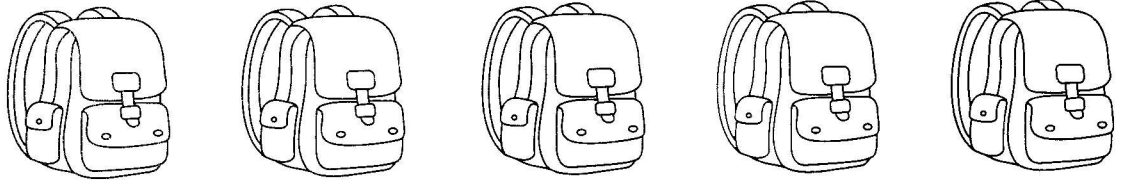

Match, repeat the actions and say.

З'єднай, повтори дії та скажи.

Sit down

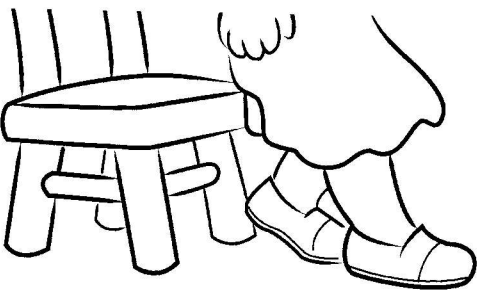
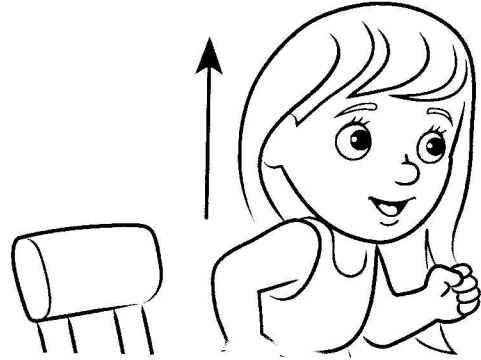
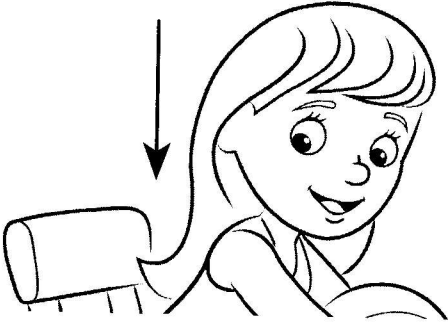

Match and say. З'єднай і скажи.

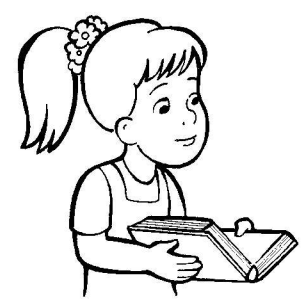
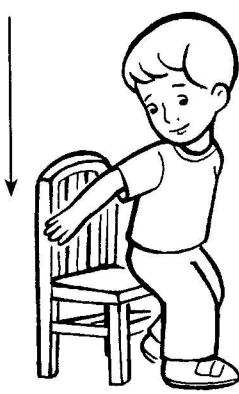
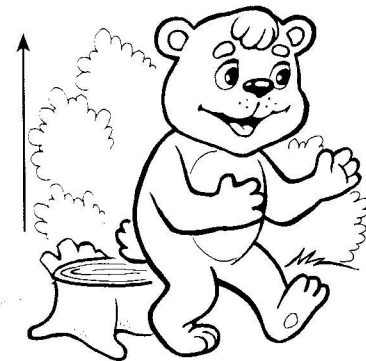
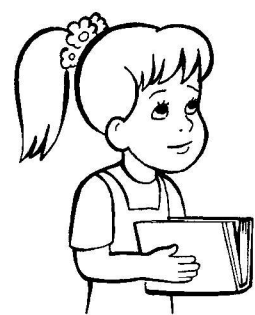
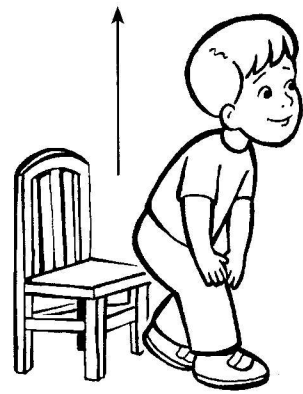

Guess, tick and say. Відгадай, познач і скажи.

Is it a ... ?

No, it isn't. / Yes, it is.

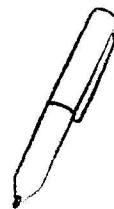
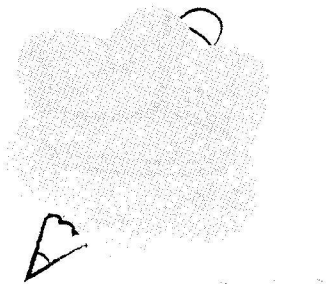
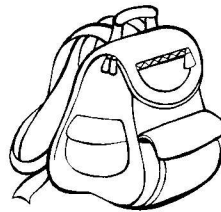
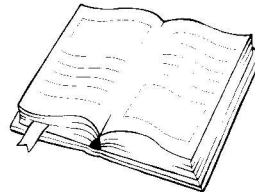
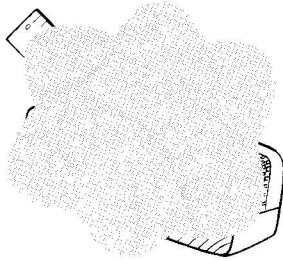
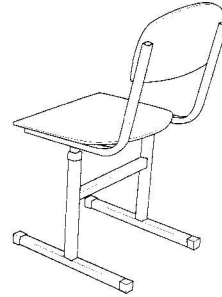
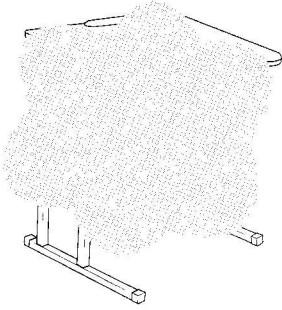

Colour and name. Розфарбуй і назви.



Draw your friends' faces and say.

Домалюй обличчя своїх друзів і скажи.

This is my friend

... .

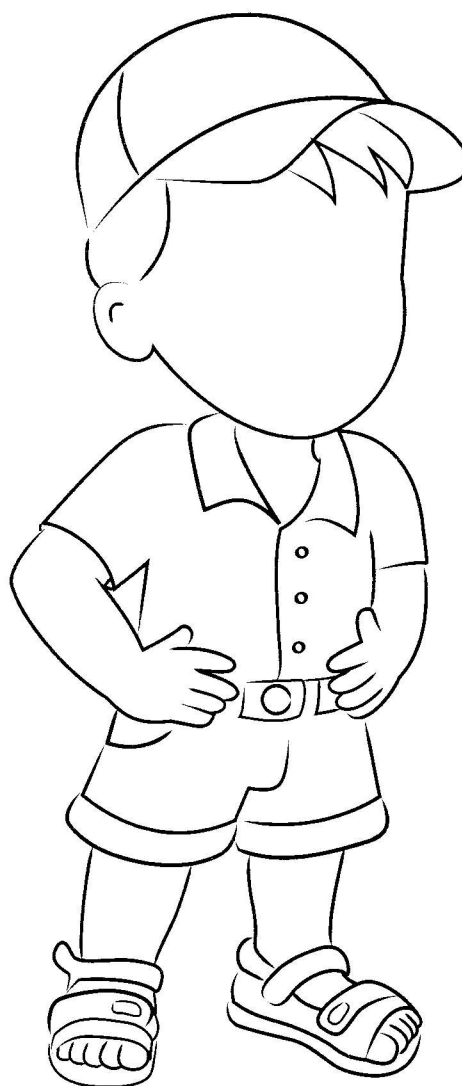

Join and say. З'єднай і скажи.

Who is this?

This is my ...

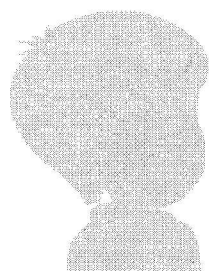
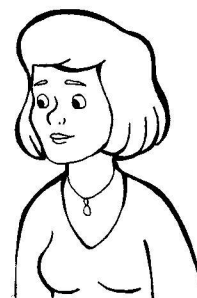
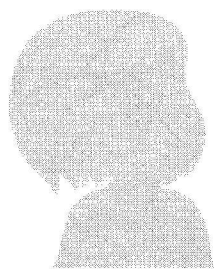
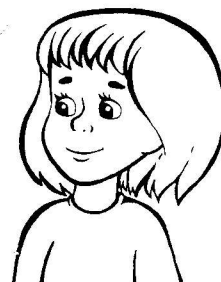
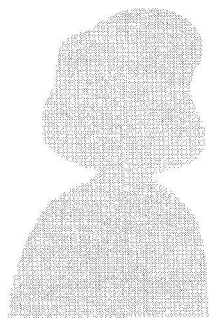

Match and say. З'єднай і скажи.

Who is this?

This is my

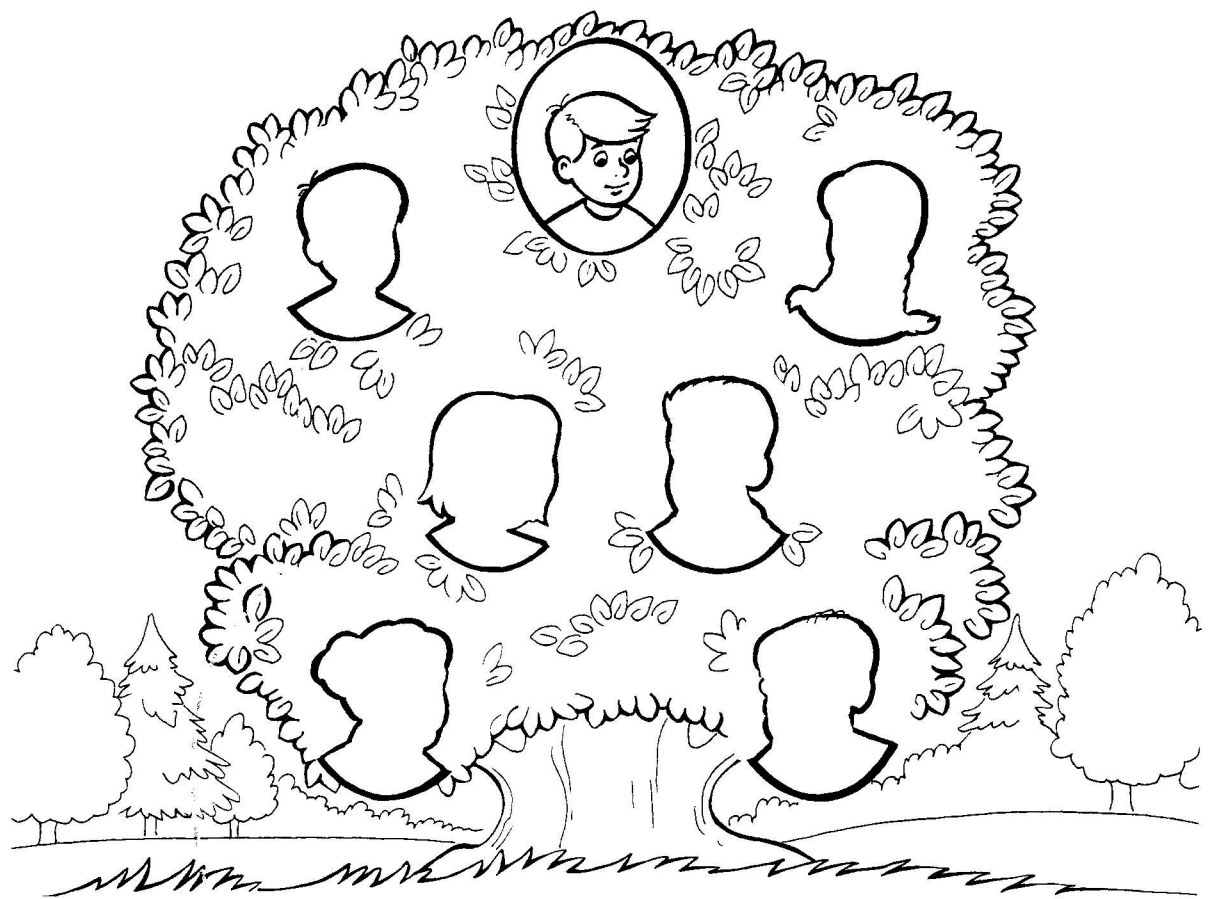

Name children and say. Colour the picture.

Дай дітям імена та скажи. Розфарбуй малюнок.

This is She/He is a

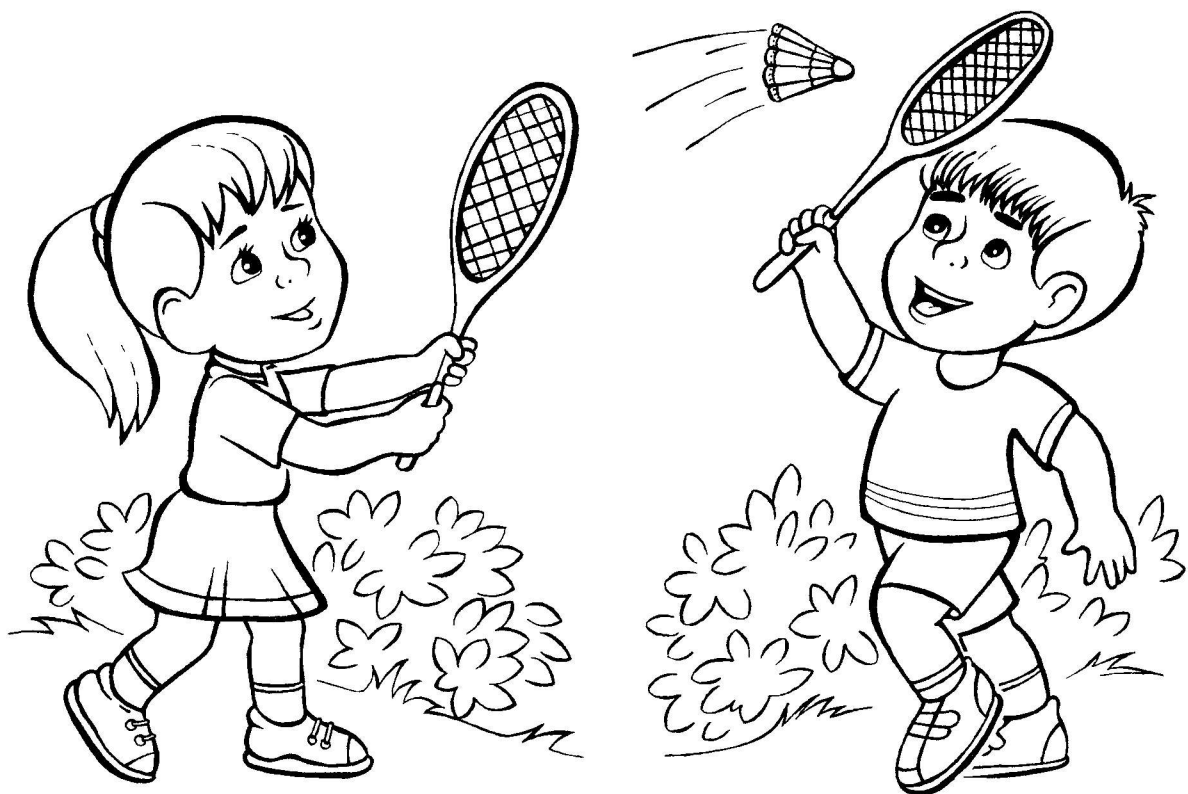
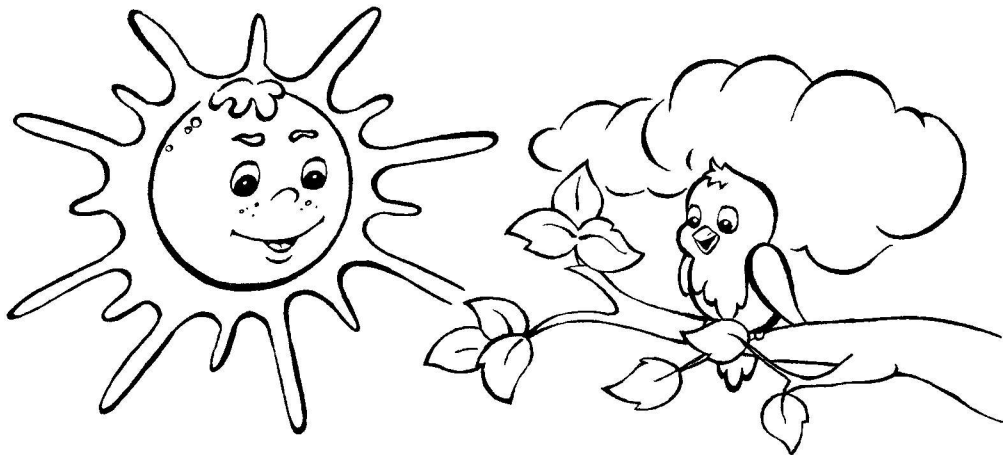

Draw your friend and say. Намалюй свого друга/подругу та скажи.

Meet

He/She is my friend.

Join, tick and say. З'єднай, познач і скажи.

Is this your ?



Draw your family and say. Намалюй свою сім'ю і скажи.

This is my family.

This is my

Guess, tick and say. Відгадай, познач і скажи.

It's a

No, it isn't. / Yes, it is.

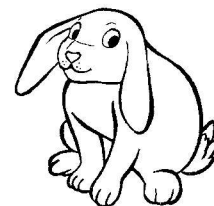
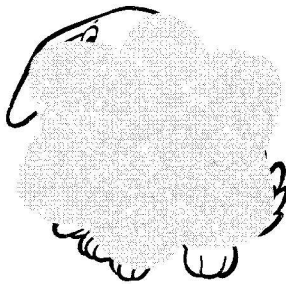
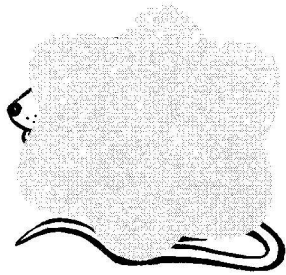
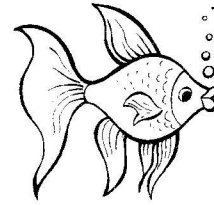
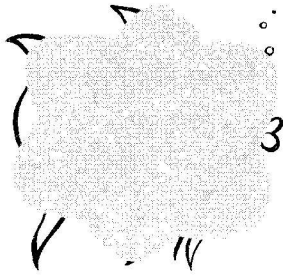
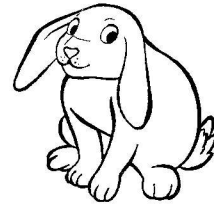
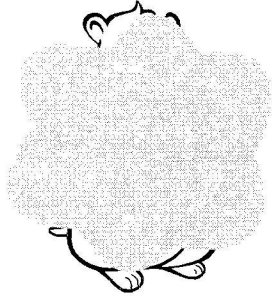

Join and say. З'єднай і скажи.

Is it a ? —

What is this? — It's a

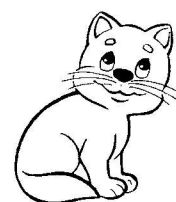
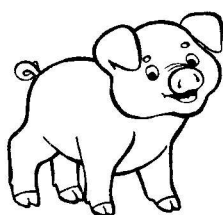
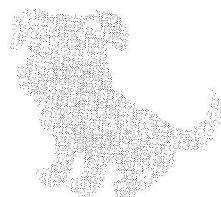
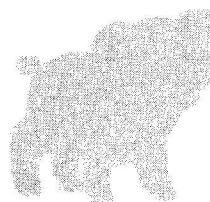
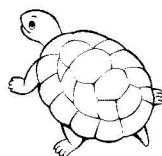
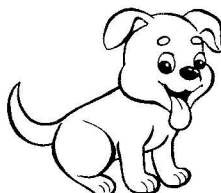

Colour the pets in different colours and say.

Розфарбуй домашніх улюбленців у різні кольори та скажи.

What is this?

It's a It's

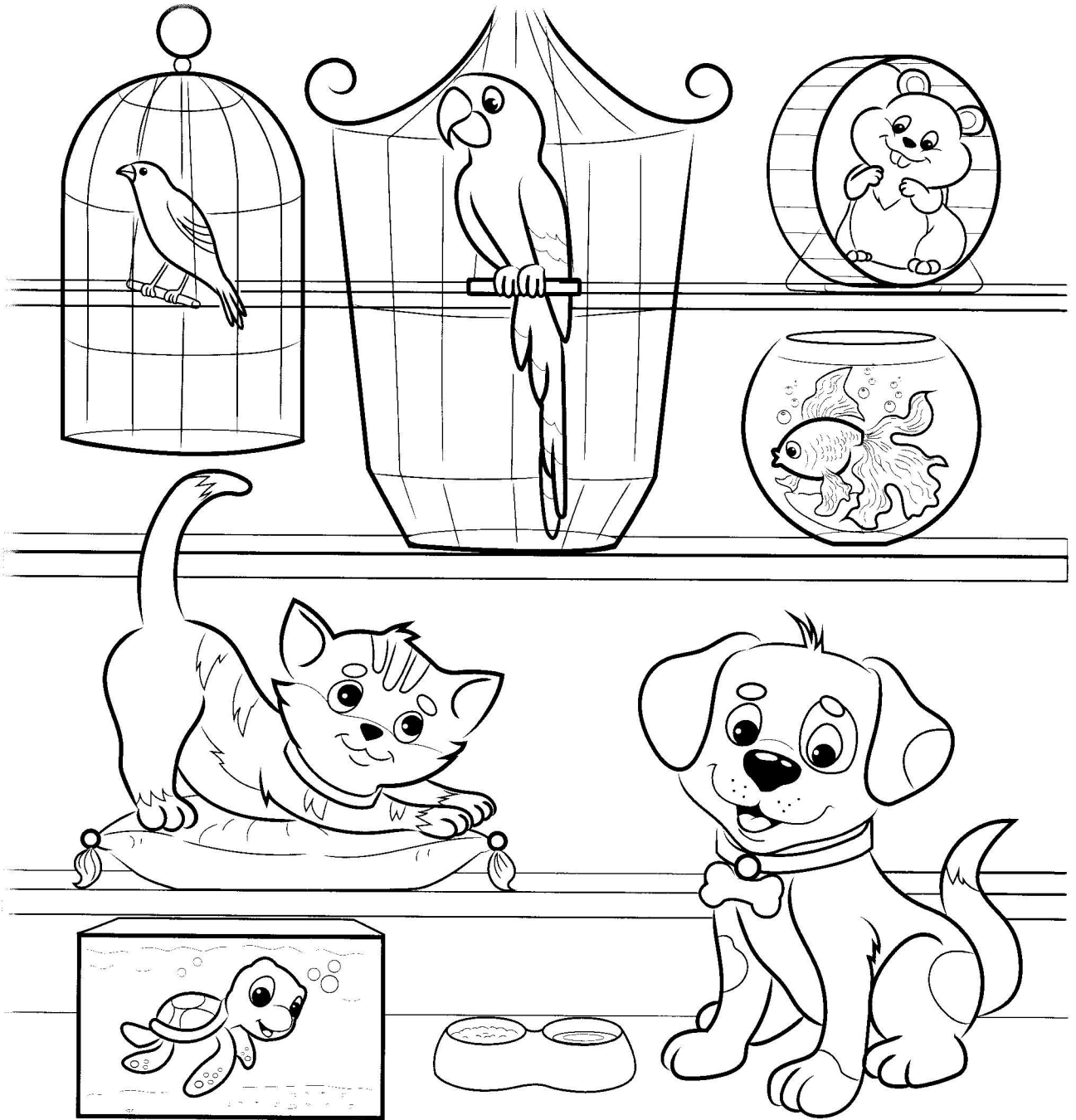

Draw your pet and say.

Намалюй свого домашнього улюбленця і скажи.

I have got a pet.

It's a It's

Tick the animals which can live in your room. Say.

Познач тварин, які можуть жити у твоїй кімнаті. Скажи.

I have got a

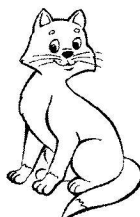
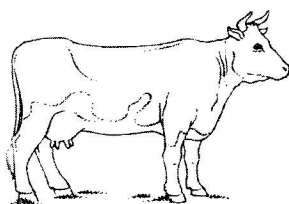
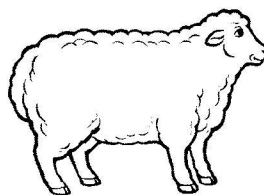
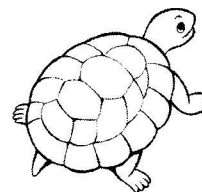
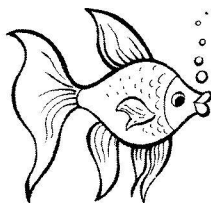
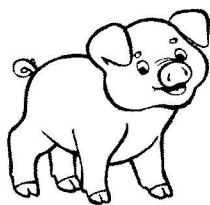
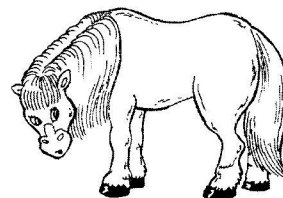
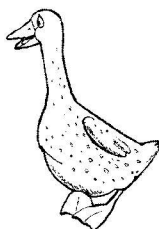
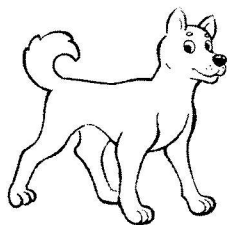

Join and say. З'єднай і скажи.

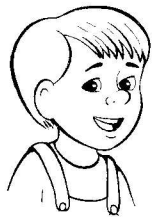

I have got a ...

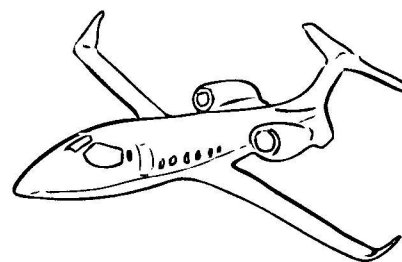
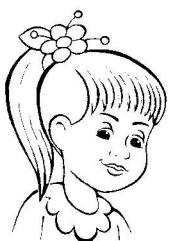
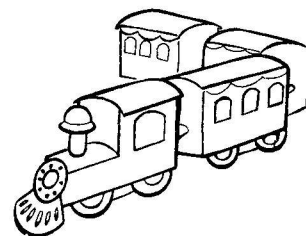
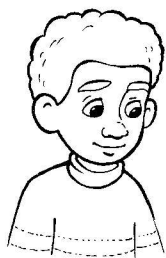
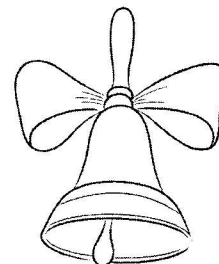
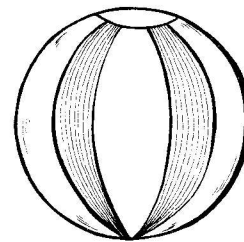

Colour and say. Розфарбуй, використовуючи код, і скажи.

What is this?

It is a

1

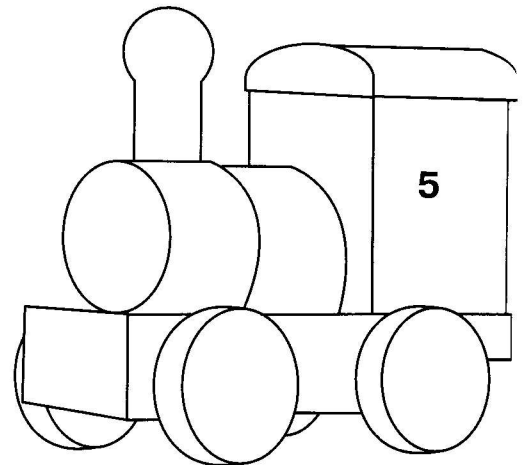
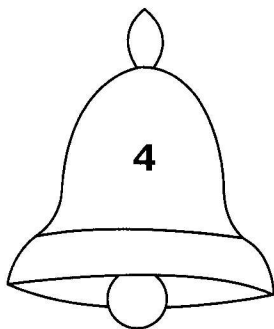
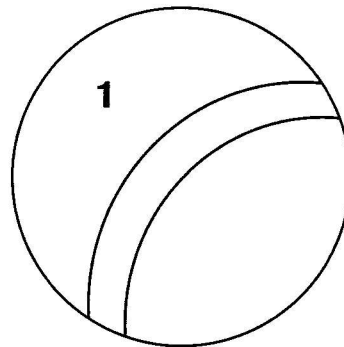
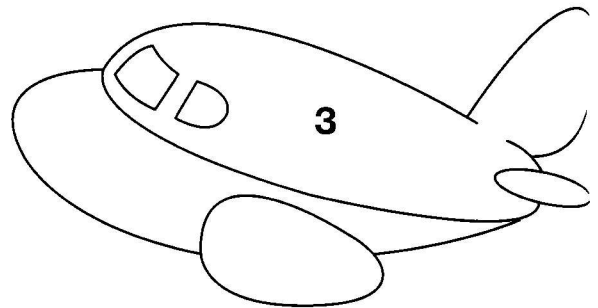
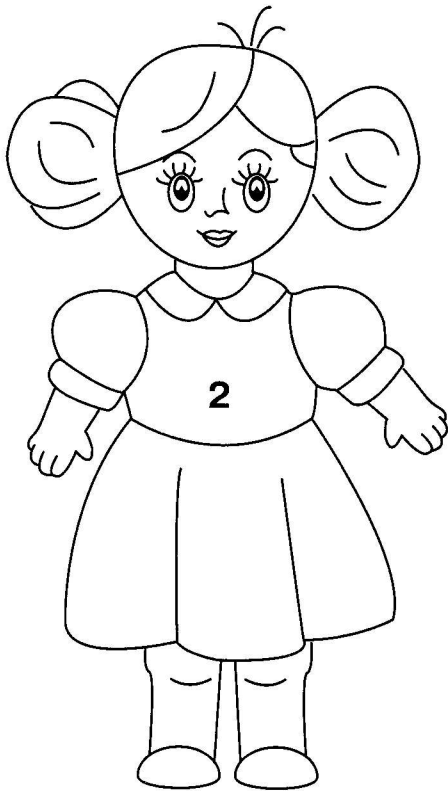
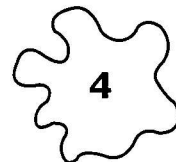
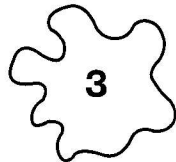
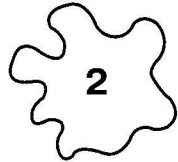

1 Name and write the letters.
Назви та напиши літери.

2 Name and match. Назви та з'єднай.

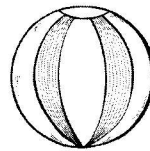
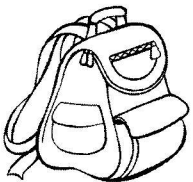
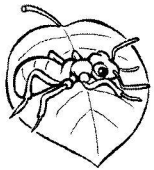

3 Name and colour the first letter.
Назви та зафарбуй першу літеру слова.



Colour the toys, join and say.

Розфарбуй іграшки, з'єднай і скажи.



is

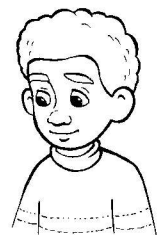
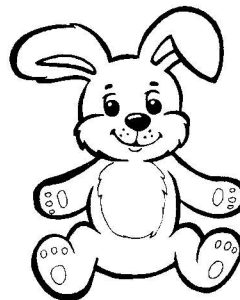
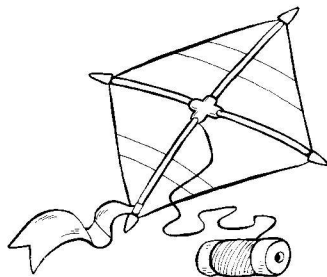
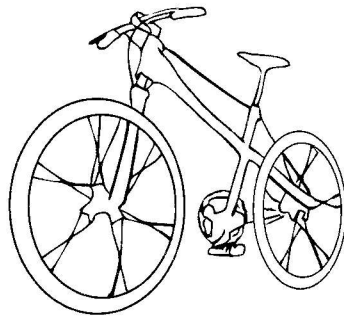
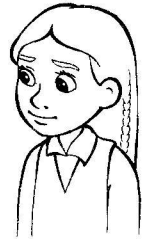

1 **Name and write the letters.**
Назви та напиши літери.

2 **Name and write the first letters.**
Назви та напиши перші літери.

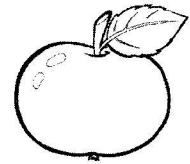
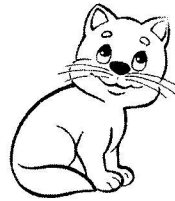
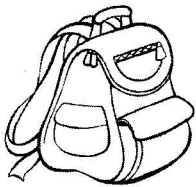

3 **Match and write. З'єднай і напиши.**

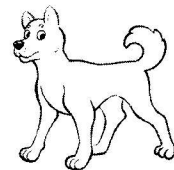

Colour only Santa and presents. Say greetings to your friends.
Розфарбуй лише Санту та подарунки. Привітай друзів зі святами.



Draw your favourite toys and say.
Намалюй свої улюблені іграшки та скажи.

Look at my toys!

I have got a

Find, trace in different colours and say.

Знайди, наведи різними кольорами та скажи.

This is a ...

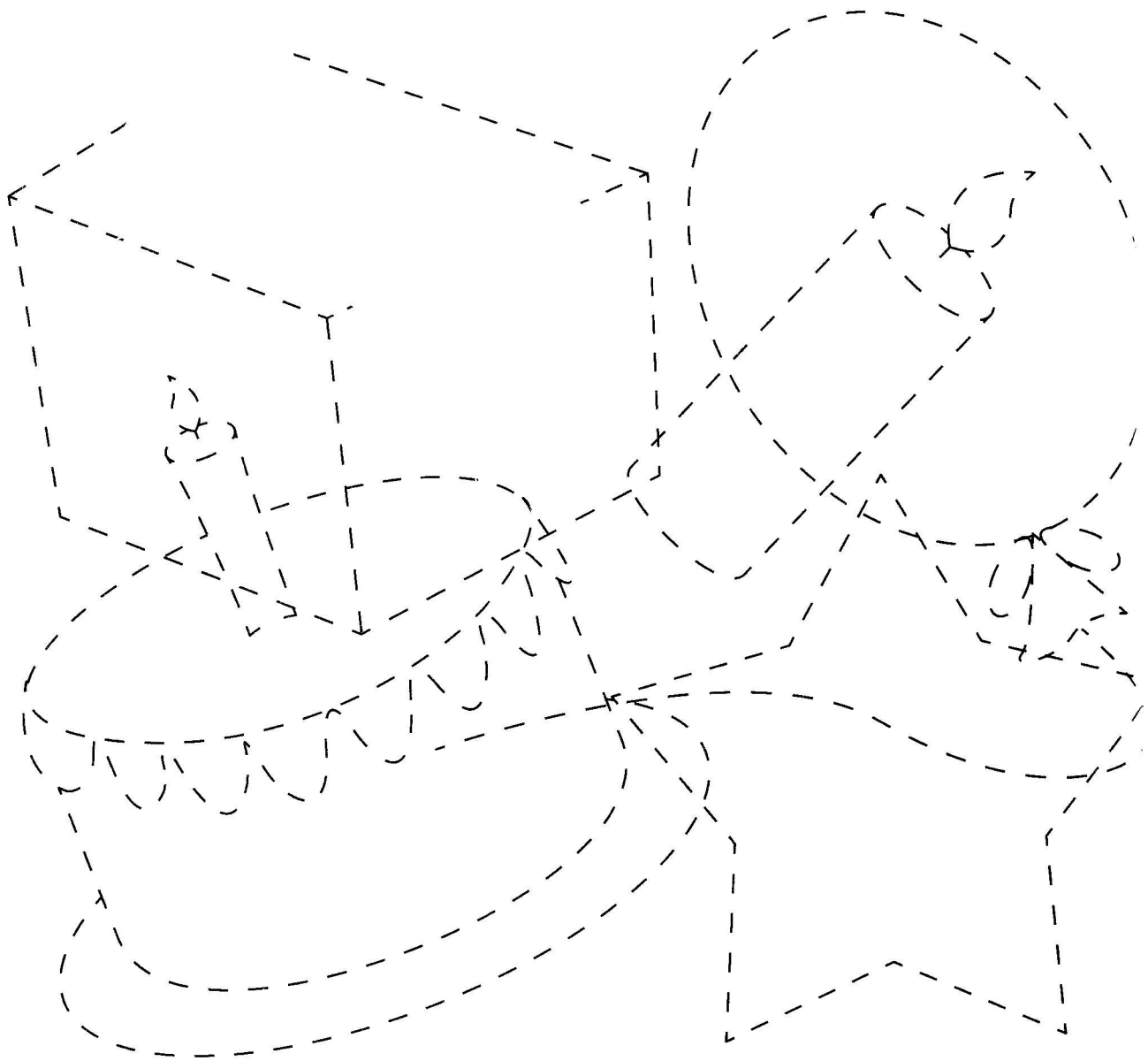
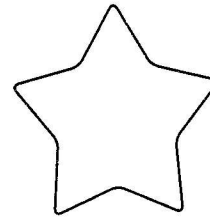
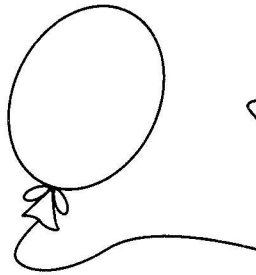
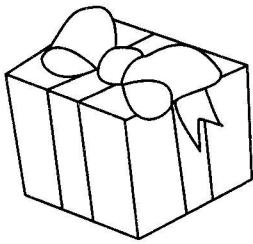

Count, write and say. Colour your birthday cake.

Полічи, напиши та скажи. Розфарбуй торт, на якому вказано твій вік.

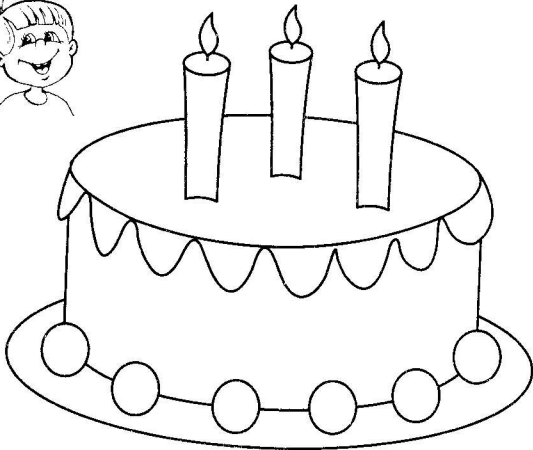

is

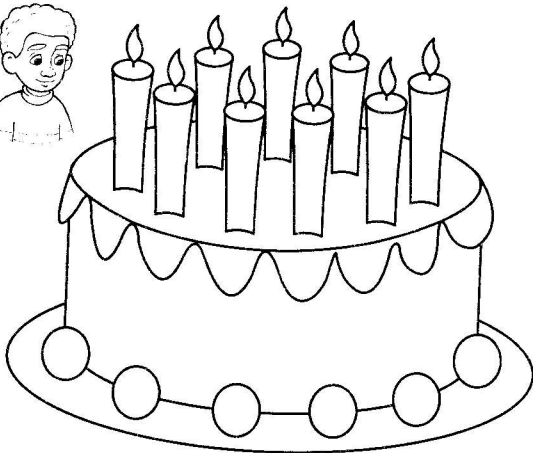

1

Name and write the letters.
Назви та напиши літери.

2

Name and match. Назви та з'єднай.

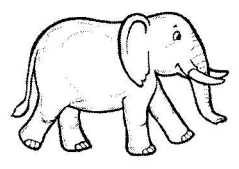
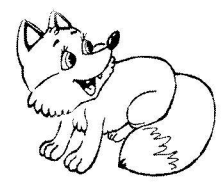
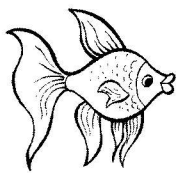

3

Circle the first letter. Обведи першу літеру слова.

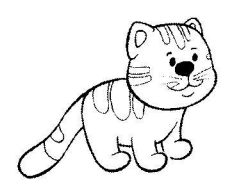
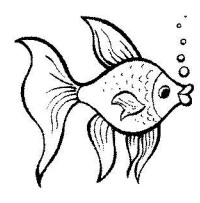
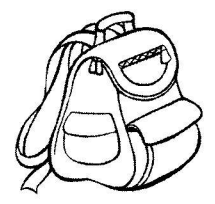
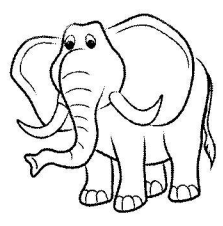

1

Name and write the letters.
Назви та напиши літери.

2

Circle the correct picture. Обведи відповідний малюнок.

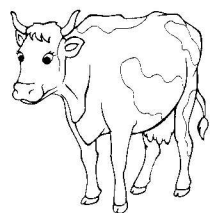
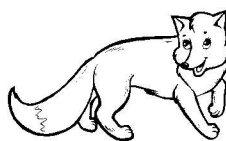
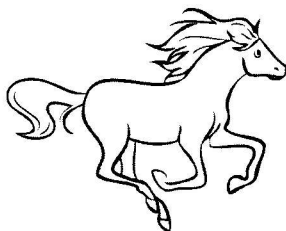
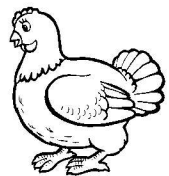
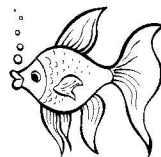
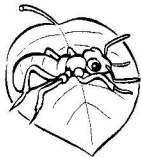
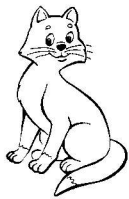

Join and say. З'єднай і скажи.

How old is ?

is



What's this? Розфарбуй подарунки та скажи.

What's this?

Wow! It's a ...

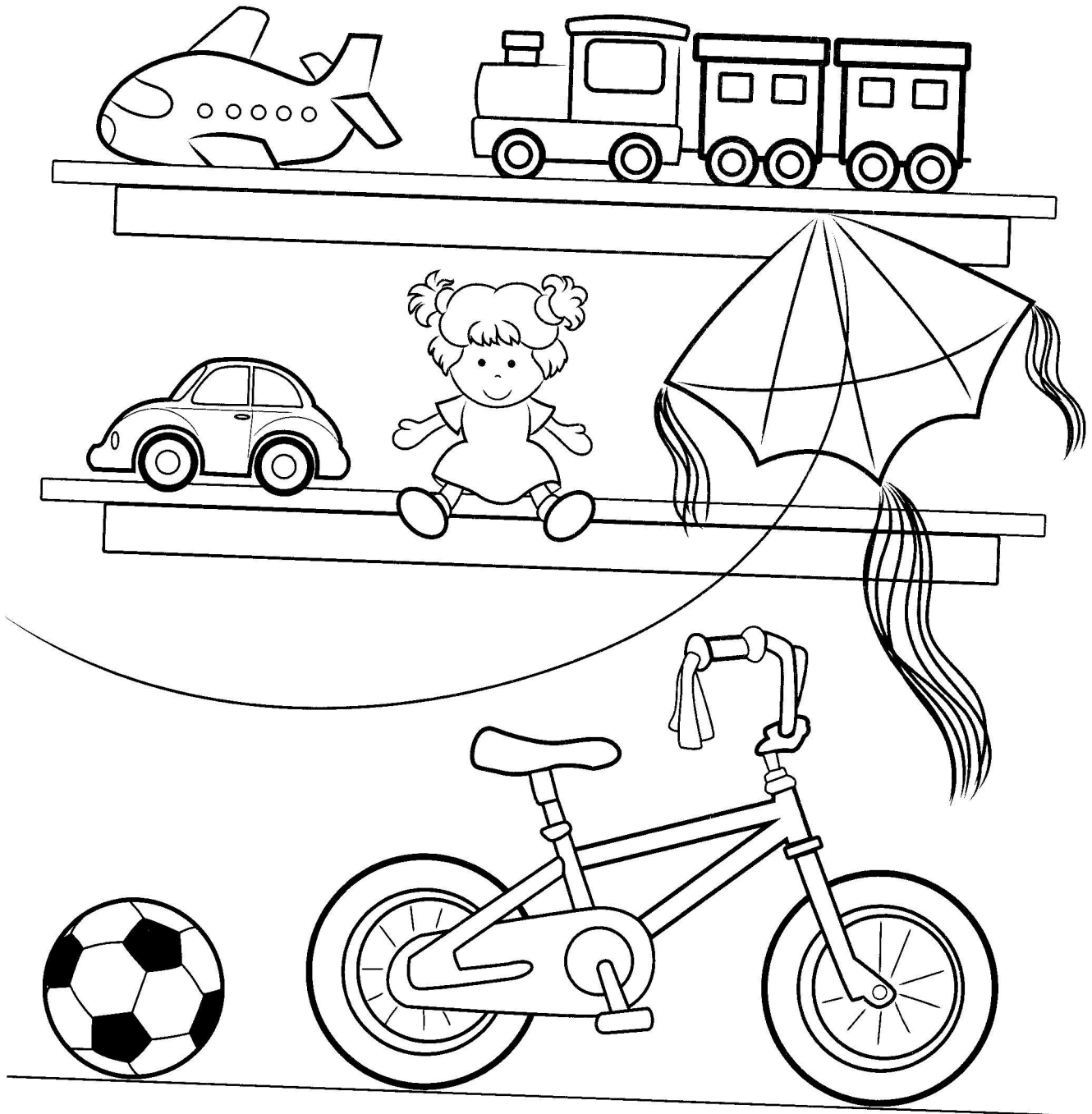

1

Name and write the letters.

Назви та напиши літери.

2

Name and match. Назви та з'єднай.

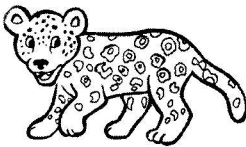
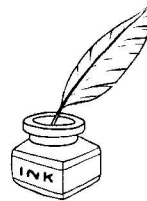
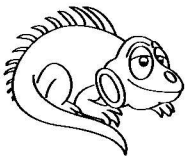

3

Trace the first letter. Наведи першу літеру слова.

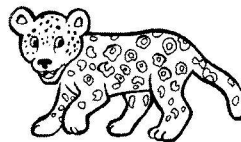
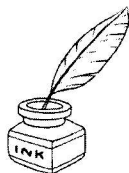
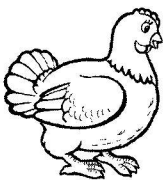

1 **Name and write the letters.**
Назви та напиши літери.

2 **Match, name and write.** З'єднай, назви та напиши.

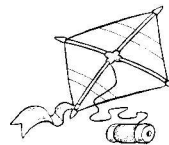
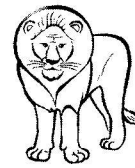

Count, circle and say. Colour the birthday card.

Полічи, обведи та скажи. Розфарбуй листівку.

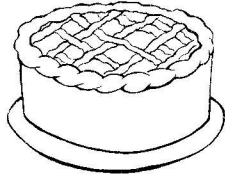

1 2

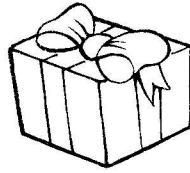

4 5



7 6

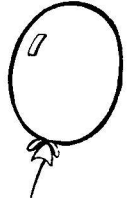

7 8



Join and say. З'єднай і скажи.

What's this?

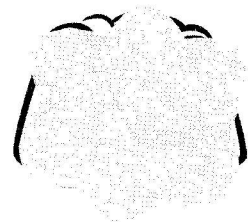
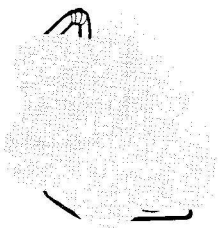
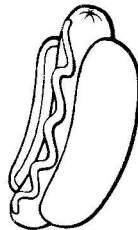
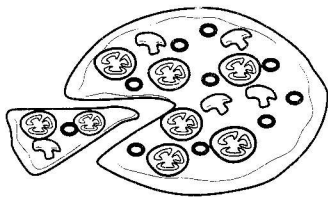
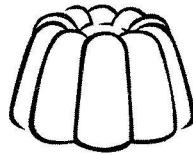
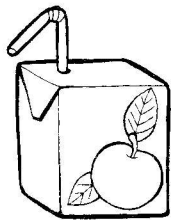
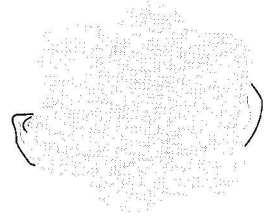
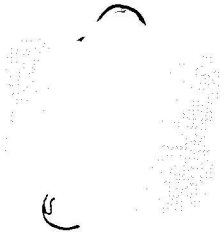

Join and say. З'єднай і скажи.

has got ... and

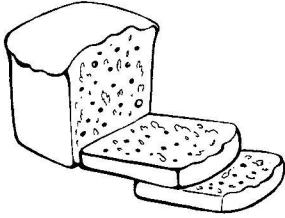

Ann

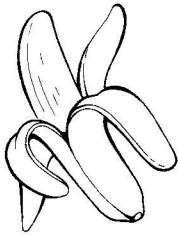
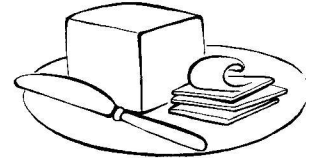

Sam

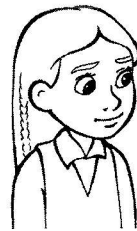
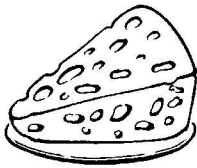
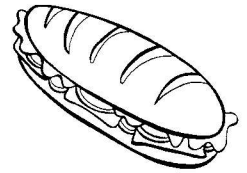

Kim

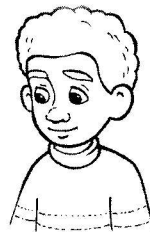
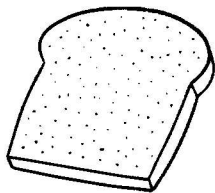

Ron



1 Name and write the letters.
Назви та напиши літери.

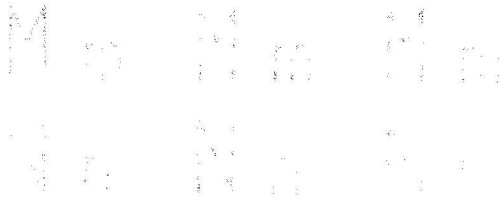

2 Trace the first letter. Наведи першу літеру слова.

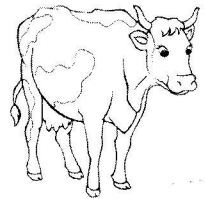
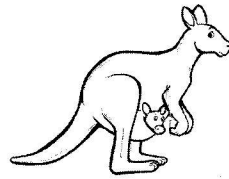
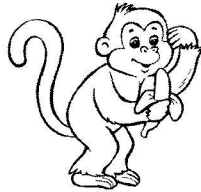
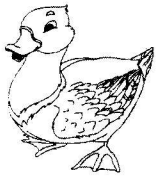

duck

monkey

kangaroo

cow

3 Match and write. З'єднай і напиши.

1

m

ino

9

2

o

oise



1 Name and write the letters.
Назви та напиши літери.

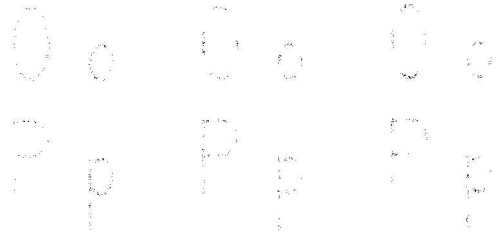

2 Circle the correct picture. Обведи відповідний малюнок.

Tick as you like and say. Познач свій вибір і скажи.

Soda or juice?

please!



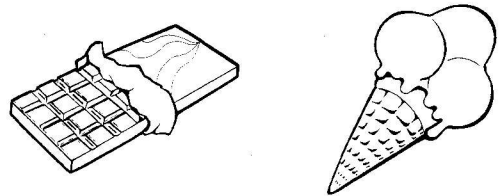
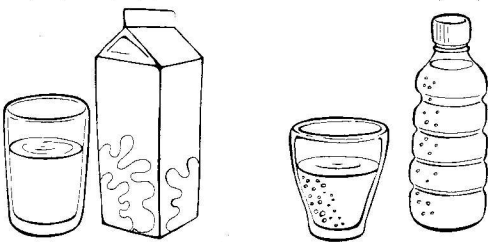
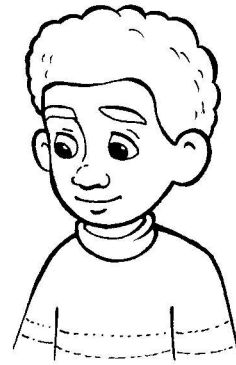
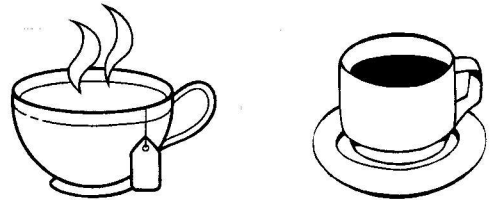
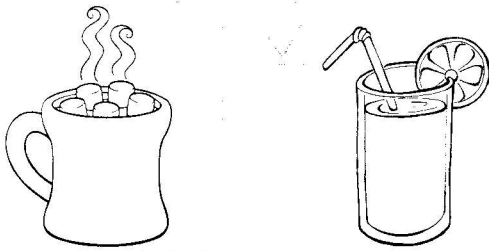
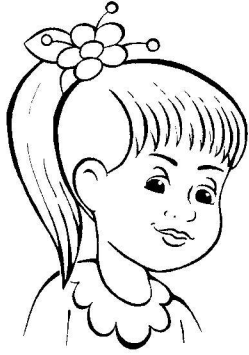

Count, write and say.

Полічи, напиши та скажи.

I've got

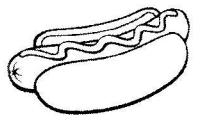
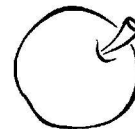
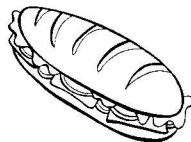
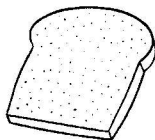
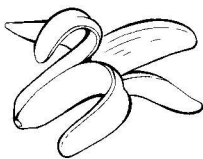
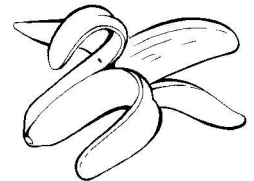
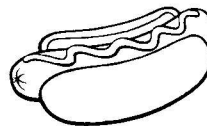
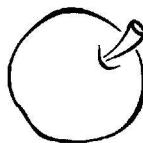
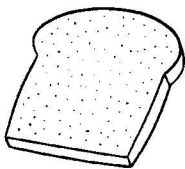
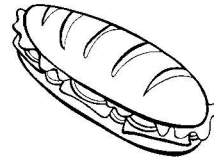
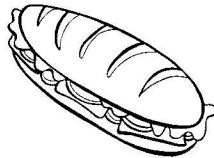
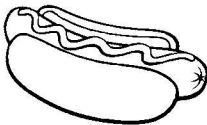
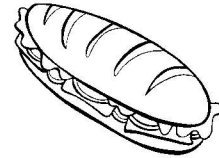
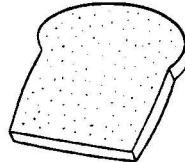
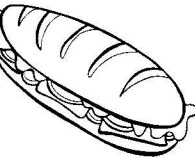
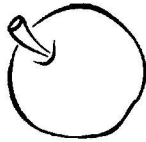
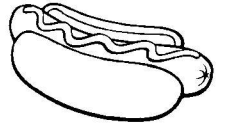
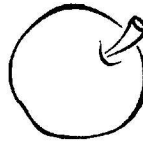
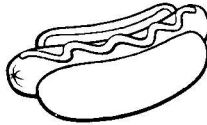
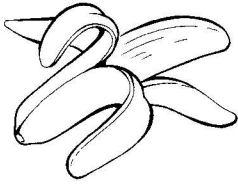
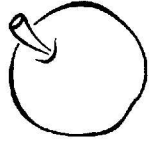
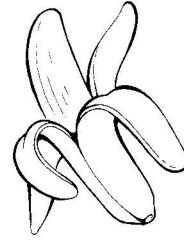
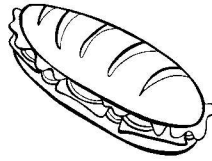
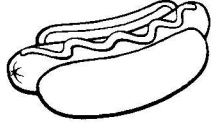
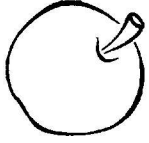

1 Name and write the letters.
Назви та напиши літери.

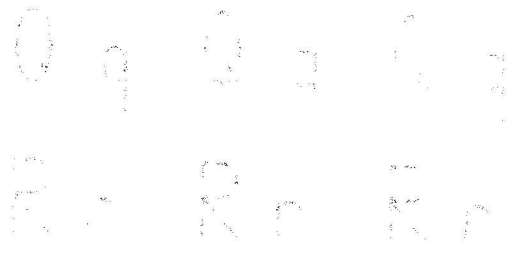

2 Circle the correct picture. Обведи відповідний малюнок.

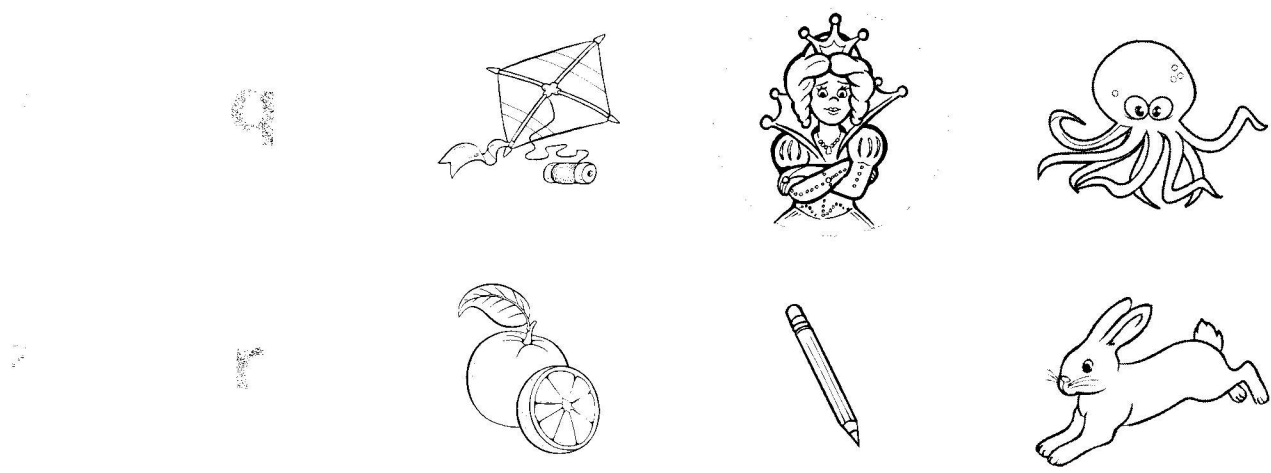

3 Name and write the first letters.
Назви та напиши перші літери.

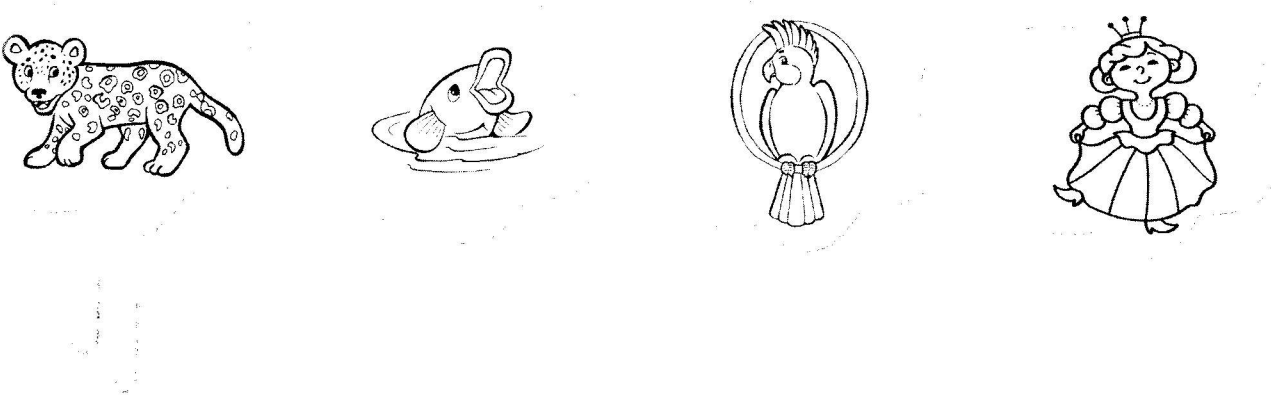

1 Name and write the letters.
Назви та напиши літери.

2 Match, name and write. З'єднай, назви та напиши.

Rr

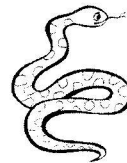

Ss

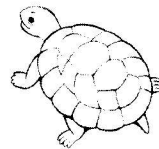

Tt

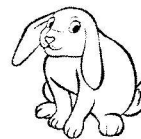

3 Guess and write the letters. Відгадай і напиши літери.

Join and say. З'єднай і скажи.

Sandwich?

Yes, please. / No, thank you.

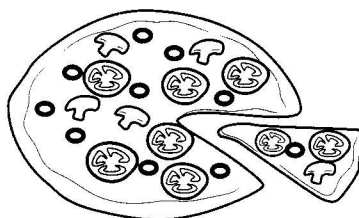
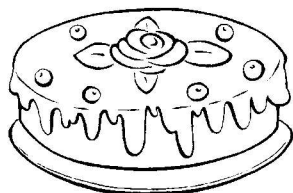
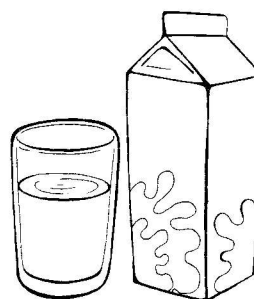
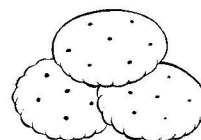
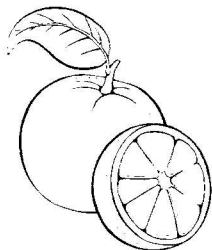
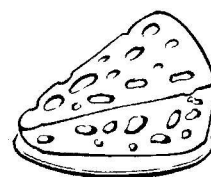
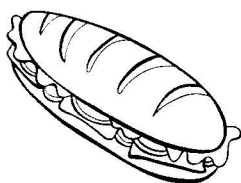
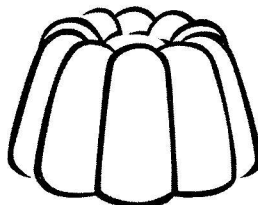
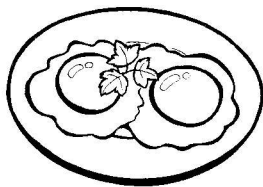

Match and say.

З'єднай і скажи.

I can

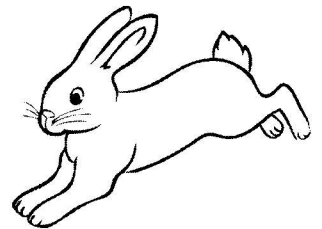
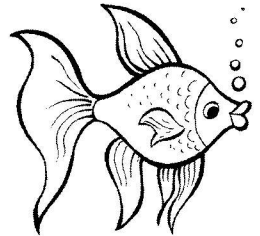
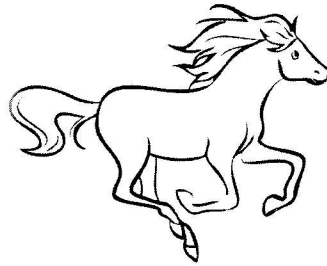
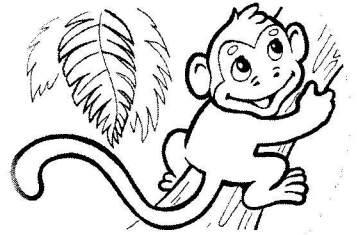

Tick as you like and say. Познач свій вибір і скажи.

can

can't

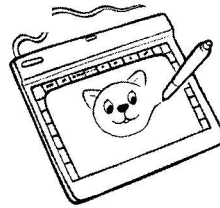
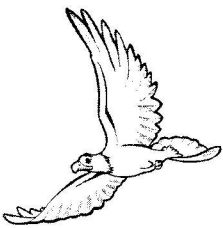
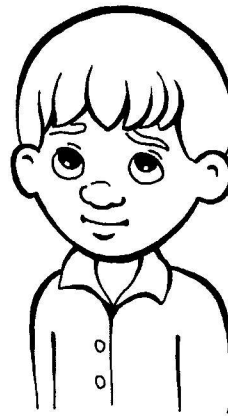
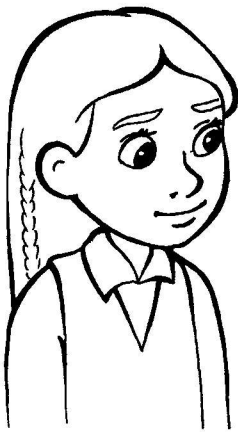
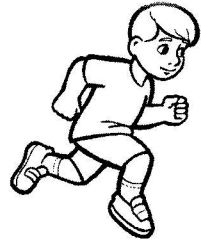
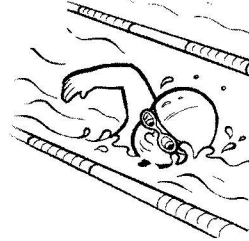
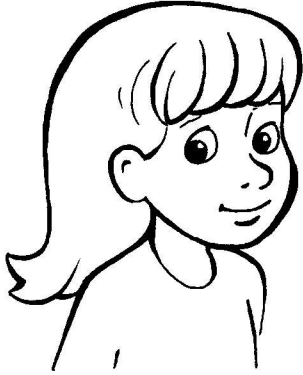

1

Name and write the letters.
Назви та напиши літери.

2

Match, name and write. З'єднай, назви та напиши.

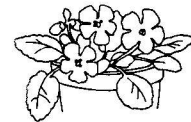

1

Name and write the letters.

Назви та напиши літери.

2

Match and write. З'єднай і напиши.

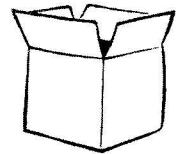

3

Write in capital letters. Запиши великими літерами.

Join and say. З'єднай і скажи.

Can you ... ? Yes, I can. / No, I can't.



1

Name and write the letters.

Назви та напиши літери.

2

Match and write. З'єднай і напиши.



3

Write in small letters. Запиши малими літерами.

Match and say. З'єднай і скажи.

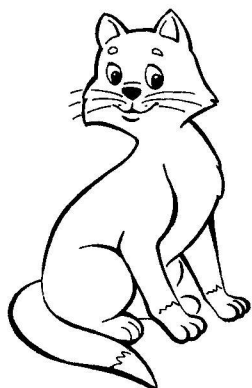

A can
It can't

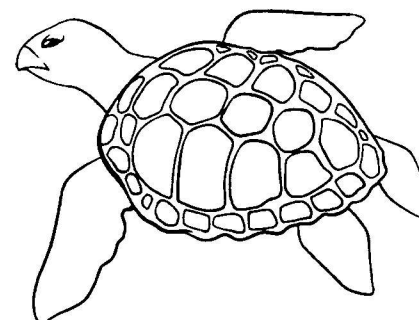
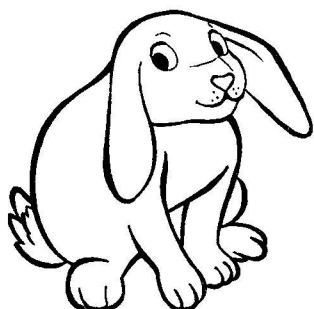

Count, write and say. Полічи, запиши та скажи.

I can see

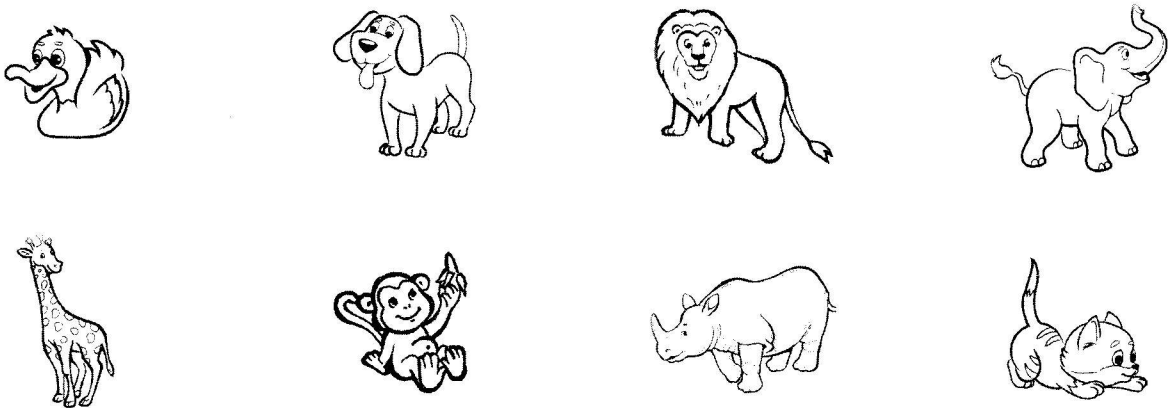
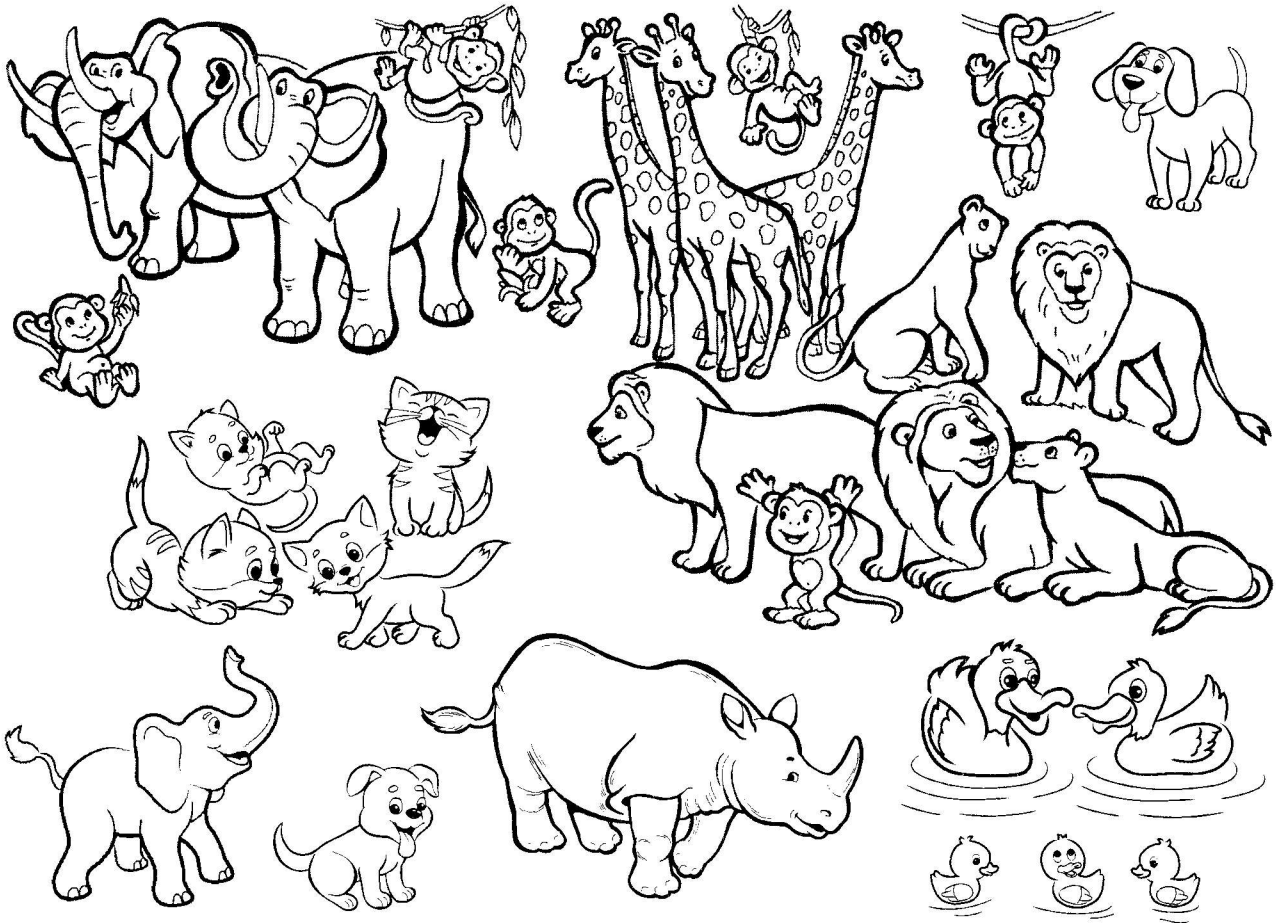

Colour happy, circle sad. Say.

Розфарбуй щасливих, обведи засмучених. Скажи.

She / He is

